



TOKYO JAPAN

Rotating Ring Disk Electrode **RRDE-3A**

Faraday cage **CS-3A**

Portable Hydrogen Generator **H2G1**

Spectrometer system **SEC2020**

Variety of products line up for research purposes



Technical notes and Movie library



Movie library

<https://www.als-japan.com/1846.html>

frontpage --> **Movie library**



Technical note

<https://www.als-japan.com/technical-note.html>

frontpage --> **Support --> Technical note**

ALS website has a "Technical note" and "Movie library" section, where you will find useful information and introduction movie of the products.

For the instrument, set up and application movies will help you in the choose of the accessories.

We will be always producing and releasing new movies, attending the demands of spectators.

Inspection data sheet download service

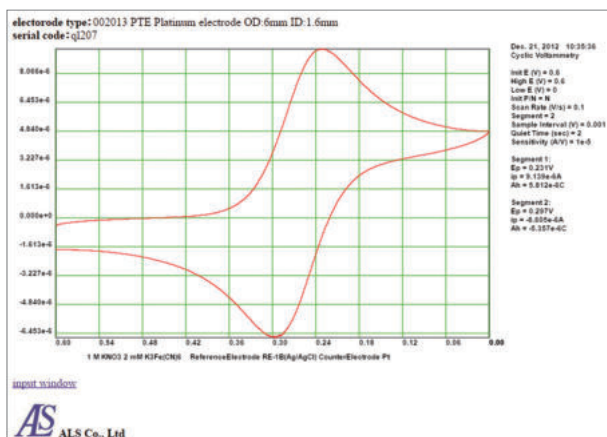

[https://www.als-japan.com/dl/Inspection data sheet link](https://www.als-japan.com/dl/Inspection%20data%20sheet%20link)

frontpage --> **Support --> Electrode data**

ALS working and reference electrodes are tested and inspected before shipment, and the check data could be confirmed through the website.

In the instruction manual, for the product which the check data is available, you will find the website direction.

Product manual download service

Instrumentation



ALS Instruments instruction manual
<https://www.als-japan.com/support-instrument-manual.html>
Manual download link

frontpage --> **Support --> Instrument Manual**

Electrodes



ALS support product manual
<https://www.als-japan.com/support-product-manual.html>
Manual download link

frontpage --> **Support --> Products Manual**

ALS product manual is available for download on website.

1

Instrumentation **2**

2

Reference Electrodes **9**

3

Working Electrodes **14**

4

Counter Electrodes **15**

5

Voltammetry Cells **20**

6

Flow Cells **23**

7

Spectroelectrochemistry **26**

8

Others **32**

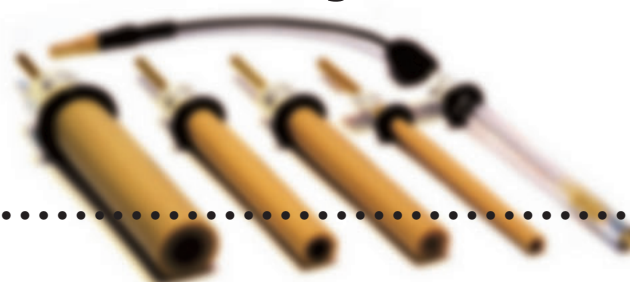

• Product appearance, specifications and price may change without notice for improvement. • The product color could be different from the printed photo. • The dimensions mentioned in the catalog are not guaranteed as the dimensions of the actual products. • The contents of this catalog is current as of February 2020.

RRDE-3A Rotating Ring Disk Electrode Apparatus

Detection of intermediate products by hydrodynamic voltammetry



ALS Instruments instruction manual
<https://www.als-japan.com/support-instrument-manual.html>
Manual download link

Catalog No.	Description	
013606	RRDE-3A Rotating Ring Disk Electrode Apparatus Ver.2.0	
Specification		
Rotational range	100 to 8,000 rpm	
Rotation stability	Error, < 1% at 100 to 1,000 rpm < 0.5% at > 1,001 rpm	
Ring/Disk insulation resistance	> 10 M ohm	
Electrode to lead pin contact resistance	5 ohm	
Rotator shaft	Stainless steel	
Motor	12 V, ironless core, low inertial DC servo	
Power	100 - 240 VAC, 50/60 Hz	
Remote control	One volt corresponds to 1,000 rpm Motor ON/OFF TTL or relay input to back panel	
Connection	Purge TTL or relay input to back panel connection	
Operating temperature	10 to 50 deg C	
Relative humidity	≤ 80%	
Size	190 x (Base: 230, Body: 120) x 400 mm	
Weight	6 kg	
Accessories		
Catalog No.	Description	Qty
013580	Sample vial for alkaline solution (100mL)	1
013271	RRDE-3A Teflon cap V.2	1
012064	Spin coating adapter	1
012065	Male connector for gas purge (PP)	1
013392	TYGON tubing, OD1/4" x ID1/8"	1
012642	RRDE-3A Silicon sheet 100 x 180 mm	1
012975	O-ring for RRDE-3A Bearing assembly	3
	Power supply cable	1
	Quick manual	1

RRDA-3A is an accurate rotator system for hydrodynamic modulation rotating ring disk voltammetry. It is precisely controlled by PWM(Pulse Width Modulation). Electrodes are small and rapidly interchangeable. The unit also provides an adjustable valve system for inert gas purging inside the cell vial.

Feature

- Operatable as RDE and RRDE systems
- Remote and manual controlled rotation and gas purge
- Compact design & Easy operation
- Cell lead connects to all potentiostats
- Spin coating
- "Cleaning" and "Replacement" warning function



ALS support RRDE
<https://www.als-japan.com/support-rrde.html>
Support Movie link

Catalog No.	Description
013580	Sample vial for alkaline solution (100mL) (10 pcs)
013581	Sample vial for alkaline solution (200mL) (8 pcs)
013582	RRDE-3A Teflon cap (for 200mL)
012632	Sample vial (100mL)
012167	RE-1B Reference electrode (Ag/AgCl)
013613	RE-1BP Reference electrode (Ag/AgCl)
012171	RE-7 Non Aqueous reference electrode (Ag/Ag ⁺)
013597	RHEK Reversible hydrogen electrode kit
012961	Platinum counter electrode 23 cm
013343	O-ring for RRDE-3A Teflon cap V.2
013645	O-ring for RRDE-3A Shaft (white), 3pcs
012641	O-ring for RRDE-3A Bearing assembly (10 pcs)

Electrodes and accessories

Disk Electrode & Ring Disk Electrode

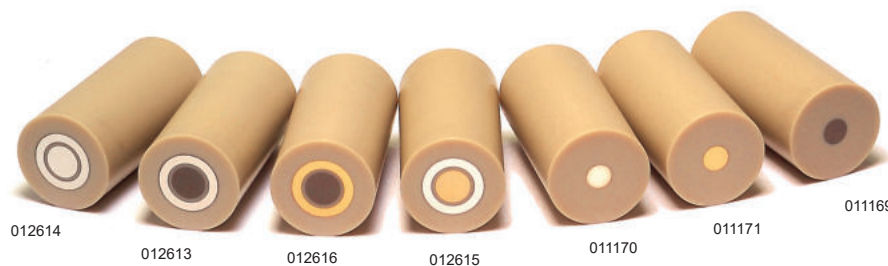

INSPECTED
https://www.als-japan.com/dl/inspection_data_sheet_link

The Ring-Disk and Disk electrodes listed below are working electrodes for RRDE-3A Rotating Ring Disk Electrode Apparatus. Organic solvent resistant resin, PEEK, is used as an insulator, and it can be polished with PK-3 Electrode Polishing kit.

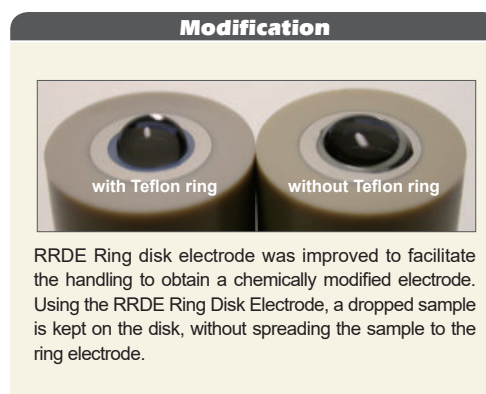
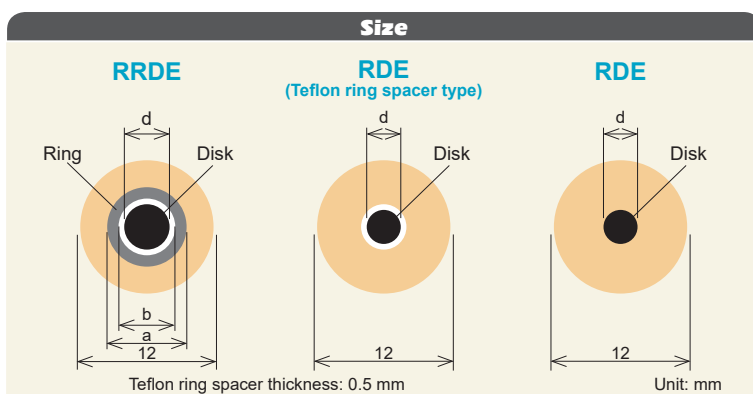

Catalog No.	Description	Electrode size		Isolation OD	Length
		Ring OD(a) / ID(b)	Disk(d)		
Ring disk electrodes					
012613	RRDE Pt ring/GC disk electrode	7 mm / 5 mm	4 mm	12 mm	25 mm
012614	RRDE Pt ring/Pt disk electrode	7 mm / 5 mm	4 mm	12 mm	25 mm
012615	RRDE Pt ring/Au disk electrode	7 mm / 5 mm	4 mm	12 mm	25 mm
012616	RRDE Au ring/GC disk electrode	7 mm / 5 mm	4 mm	12 mm	25 mm
012617	RRDE Au ring/Pt disk electrode	7 mm / 5 mm	4 mm	12 mm	25 mm
012653	RRDE Au ring/Au disk electrode	7 mm / 5 mm	4 mm	12 mm	25 mm
012618	RRDE GC ring/GC disk electrode	7 mm / 5 mm	4 mm	12 mm	25 mm
Disk electrodes					
011169	RDE GCE Glassy carbon disk electrode	-	3 mm	12 mm	25 mm
013490	RDE GCET Glassy carbon disk electrode ^{*1}	-	3 mm	12 mm	25 mm
013482	RDE GCE Glassy carbon disk electrode	-	5 mm	12 mm	25 mm
013491	RDE GCET Glassy carbon disk electrode ^{*1}	-	5 mm	12 mm	25 mm
011170	RDE PTE Platinum disk electrode	-	3 mm	12 mm	25 mm
011171	RDE AUE Gold disk electrode	-	3 mm	12 mm	25 mm
011966	RDE ALE Aluminum disk electrode	-	3 mm	12 mm	25 mm
011967	RDE AGE Silver disk electrode	-	3 mm	12 mm	25 mm
011968	RDE CUE Copper disk electrode	-	3 mm	12 mm	25 mm
011969	RDE NIE Nickel disk electrode	-	3 mm	12 mm	25 mm
011970	RDE TAE Tantalum disk electrode	-	3 mm	12 mm	25 mm
011971	RDE TIE Titanium disk electrode	-	3 mm	12 mm	25 mm
011972	RDE WE Tungsten disk electrode	-	3 mm	12 mm	25 mm
011973	RDE CPE Carbon paste disk electrode ^{*2}	-	3 mm	12 mm	25 mm

*1. Teflon ring spacer type. It is easier to apply the catalyst than the conventional glassy carbon disk electrode.

*2. 001010 CPO Carbon paste (1 g) is sold separately (p.9). Note that the carbon paste is not filled up.

DRE Disk Replaceable Electrode



Disk Replaceable Electrode (DRE) has a removable disk electrode. The replacement of the disk electrode is possible from both side, front side and rear side. It makes possible to choose, according to the condition required for your research purpose.

Feature

1. Assessment of the disk electrode using the same ring electrode, could avoid the influence of the ring material and dimension.
2. Removable disk and ring assembly make possible modification of the electrode surface and polishing process, separately.
3. Disposable disk could be used.



ALS support product manual
<https://www.als-japan.com/support-product-manual.html>
Manual download link



INSPECTED
<https://www.als-japan.com/dl/>
Inspection data sheet link

DRE Disk Replaceable Electrode (RRDE)



Catalog No.	Description	
013336	DRE-PGK Pt ring/GC disk replaceable electrode kit	
013641	DRE-GGK GC ring/GC disk replaceable electrode kit	
Contents		
013337	DRE-PTR Pt ring assembly	1
013642	DRE-GCR GC ring assembly	1
013339	DRE-SPC Teflon spacer (3 pcs)	1
013338	DRE-GCD GC disk	1
Optional items		
013366	DRE-AUD Au disk	
013367	DRE-PTD Pt disk	

DRE Disk Replaceable Electrode (RDE)



Catalog No.	Description	
013362	DRE-GCK GC disk replaceable electrode kit	
013364	DRE-AUK Au disk replaceable electrode kit	
013365	DRE-PTK Pt disk replaceable electrode kit	
Contents common for the kits		
013361	DRE-DAS Disk assembly	1
013339	DRE-SPC Teflon spacer (3 pcs)	1
Optional items		
013338	DRE-GCD GC disk	
013366	DRE-AUD Au disk	
013367	DRE-PTD Pt disk	

DRE-DCP Disk electrode polishing and exchanging tool kit

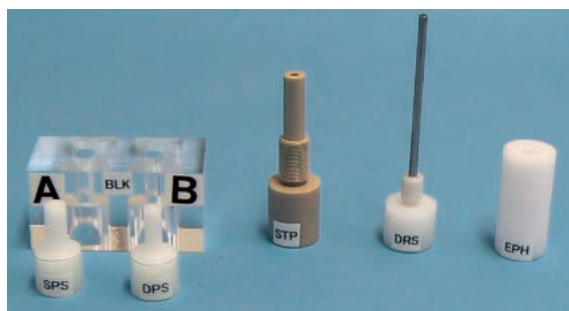

Catalog No.	Description	
013608	DRE-DCP Disk electrode polishing and exchanging tool kit	
Contents		
	DRE-BLK Base block	1
	DRE-STP Stopper	1
	DRE-DRS Disk remove tool	1
	DRE-SPS Spacer push tool	1
	DRE-DPS Disk push tool	1
	DRE-EPH Electrode polishing holder	1

Handling sketch of the DRE

The DRE-STP Stopper is screwed to the DRE-PTR Pt ring assembly. It works for the adjustment of the height, when the DRE-SPC Teflon spacer and DRE-GCD GC disk are attached. In the DRE-BLK Base block, the "A" side is for the DRE-SPC Teflon spacer attachment, and "B" side is for the DRE-GCD GC disk attachment.

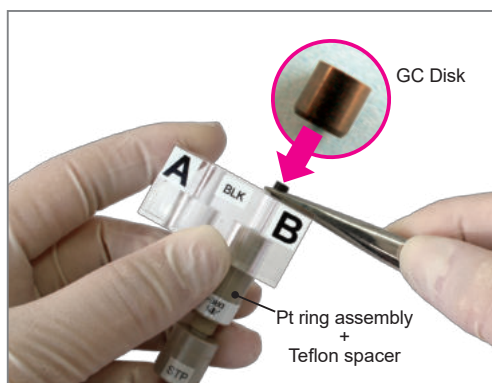

Fig.1-1

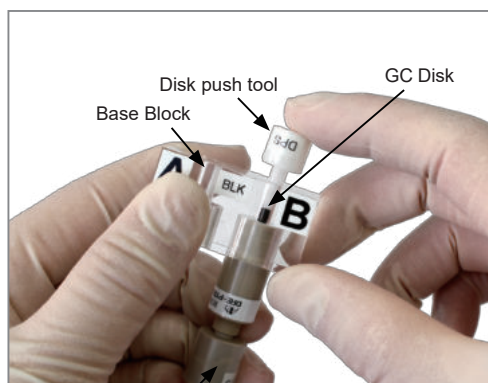

Fig.1-2



Fig.1-3

After fixed and adjusted the height of the DRE-SPC Teflon spacer in to the DRE-PTR Pt ring assembly, in the "A" side, move the DRE-PTR Pt ring assembly to the "B" side, for the setting of the DRE-GCD GC disk from the front side, as shown above. Put the DRE-GCD GC disk from the front side (Fig.1-1) and adjust it with DRE-DPS Disk push tool (Fig.1-2). Take out from the DRE-BLK Base block and adjust the height with DRE-STP Stopper and DRE-DRS Disk remove tool, until have the flat surface (Fig.1-3).



ALS support RRDE
<https://www.als-japan.com/support-rrde.html>
Support Movie link

RRDE Disk replaceable electrode assessment test

The illustration in the section above shows the fitting of the DRE-GCD Glassy carbon disk from the front side, however for the performance test of the electrode, both way, front side and rear side was done.

Typical test parameters are:

- Working electrode : DRE-RRDE Pt ring GC disk electrode
- Reference electrode: Ag/AgCl
- Counter electrode : Platinum wire
- Test solution : 2 mM potassium ferricyanide/1 M KNO₃
- Initial voltage : + 600 mV
- Final voltage : - 200 mV
- Scan Rate (Volt) : 10 mV/S
- Rotation Rate : 100 to 3,000 rpm
- Sensitivity : 10⁻⁵ A/V
- 2nd potential : + 600 mV

Fitting for the front side:

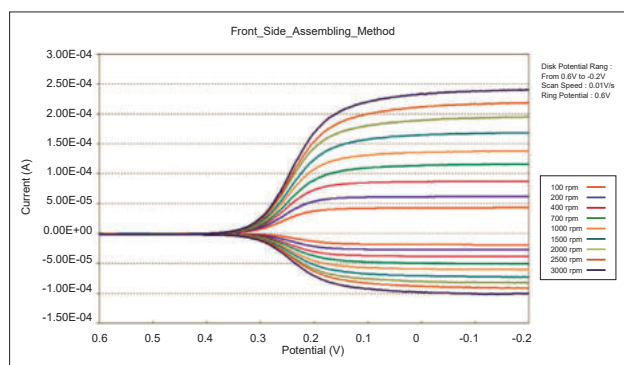

Fitting for the rear side:

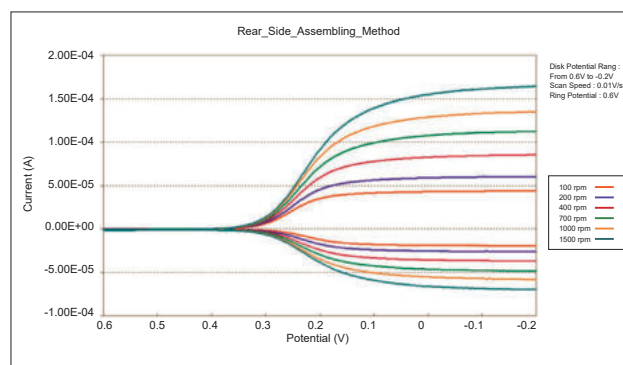

Model 2325 Bi-Potentiostat for RRDE-3A

Low-price and high-performance electrochemical analyzer



Feature

- Bi-Potentiostat
- High-performance
- Compact design
- RRDE system control
- Wide applications
- Repetitive and sequence run



ALS Instruments instruction manual
<https://www.als-japan.com/support-instrument-manual.html>
Manual download link

Catalog No.	Description
013345	Model 2325 Bi-Potentiostat
013349	Model 2325 Software
Specification	
Potential range	±4 V
Current range	±50 mA
Sensitivity range	1×10 ⁻⁷ - 0.05 A/V
Input impedance	1×10 ¹² Ω
Min. Potential Step	1.0 mV
Maximum sampling rate	10 kHz
Maximum data points	15000 points (65000 depends on the setting)
Background current	< 0.2 nA
Current Resolution	3 pA
Scan rate (CV)	1×10 ⁻³ - 10 V/sec
Operating system	Windows™ 8.1 / 10
Dimensions (W×D×H)	150 × 260 × 50 mm
Weight	1 kg
Software Techniques & Measurement range	
CV	1×10 ⁻³ - 10 V/sec
LSV	1×10 ⁻³ - 10 V/sec
i-t	1×10 ⁻⁴ - 10 sec (sampling interval)
OCP-T	1×10 ⁻⁴ - 10 sec (sampling interval)
RDE (0-10 V output)	0 - 10 V output

Model 2325 is a very low-price and high-performance Bi-Potentiostat based on modern semiconductor circuitry and advanced software technology. Low noise, high speed and small space measurement were considerate for the development of Model 2325. The user-friendly interface is designed for supporting wide applications. Model 2325 can be applied in various experiments, such as RRDE, sensor development and spectroelectro-chemical measurements, etc. It can be not only applied for research purpose, but also for student experiments and industrial applications due to the low-price and high-performance.

Configuration for the experimental system

Fuel cell and corrosion evaluation



Model 2325



RRDE-3A

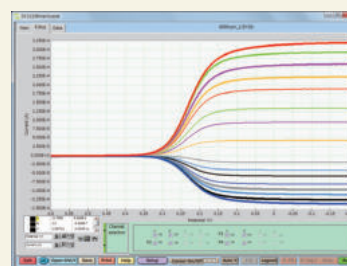

Spectroelectrochemical measurement



Model 2325



Spectroelectrochemical cell

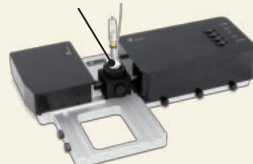

SEC2020 Spectrometer system

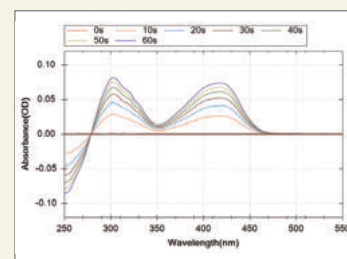

CS-3A Cell Stand

Faraday cage for electrochemical measurements



Feature

- Reduction of external electrical interference
- Gas purge ON/OFF remote control
- Manual and remote ON/OFF control of magnetic stirrer
- Reduced corrosion by using stainless steel tray

Catalog No.	Description
012779	CS-3A Cell Stand Ver.1.1
Specification	
Power supply	100 VAC - 240 VAC, 50/60 Hz
Fuse	1 A
Gas pressure	< 34 kPa
Temperature	10 - 50 deg C
Size (W x D x H)	286 x 230 x 320 mm
Weight	3.8 kg



ALS Instruments instruction manual
<https://www.als-japan.com/support-instrument-manual.html>
Manual download link

CS-3A Cell Stand is specifically designed to use a variety of solid electrodes conveniently and cell accessories available from ALS. The working cell is enclosed in a Faraday cage to reduce external electrical interference. A built-in gas control allows purging of the sample. Manual and remote control of the magnetic stirrer allows for controlling the mixing of the sample for experiments requiring mass transfer of electrolyte or analyte to the electrode surface.

Point 1

Stainless steel support setting at the back, to keep space free for sample handling.

SVC-2/SVC-3 Voltammetry cell can be firmly fixed in the support.

Point 2

In addition to the cell cable hole, a semicircular cut out with a 15 mm of radius was added to the back panel.

Water-Jacketed glass cell inlet/outlet tubes can be setting through the back.

CV measurement performed with Microelectrode

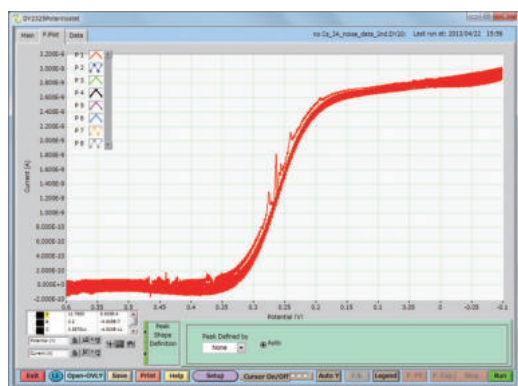

Noise level without CS-3A Cell Stand

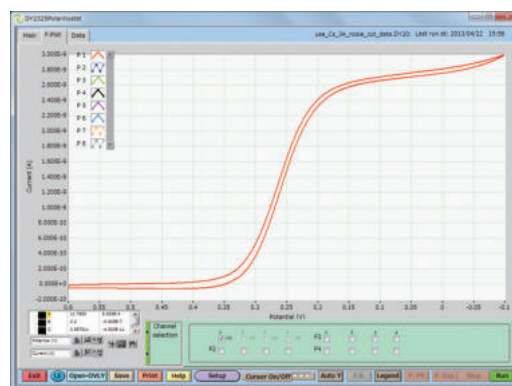

Noise level with CS-3A Cell Stand

The measured current value using the Microelectrode is very small, and it becomes vulnerable for external noise. CS-3A could avoid the experimental irregular result, a result caused by the external noise.

H2G1 Portable Hydrogen Generator NEW



Feature

- Electrolysis and quickly potential measurement
- Filling time: about 5 min (for 1.2 mol HCl solution)
- Can be used with four AAA batteries

Catalog No.	Description
013699	H2G1 Portable Hydrogen Generator
Specification	
Output current	10 mA \pm 30%
Output Voltage	28 V
Potential measurement range	about 10 - 999 mV
Operating temperature and humidity range	10 - 50 deg C \leq 80% RH
Power	four AAA batteries
Size	about 81 (W) x 32 (H) x 141 (D) mm
Weight	about 270 g
Accessories	Cable (red, white, black) 45 cm each

Portable hydrogen generator is used to generate hydrogen by electrolysis to prepare Reversible Hydrogen Electrode (RHE). The practical and safety reversible hydrogen electrode (RHE) can be prepared by using this instrument for hydrogen gas generation for a RHEK Reversible hydrogen electrode kit. This prepared reversible hydrogen electrode has high accuracy, stability and can be the perfect alternative for the traditional standard hydrogen electrode (SHE).

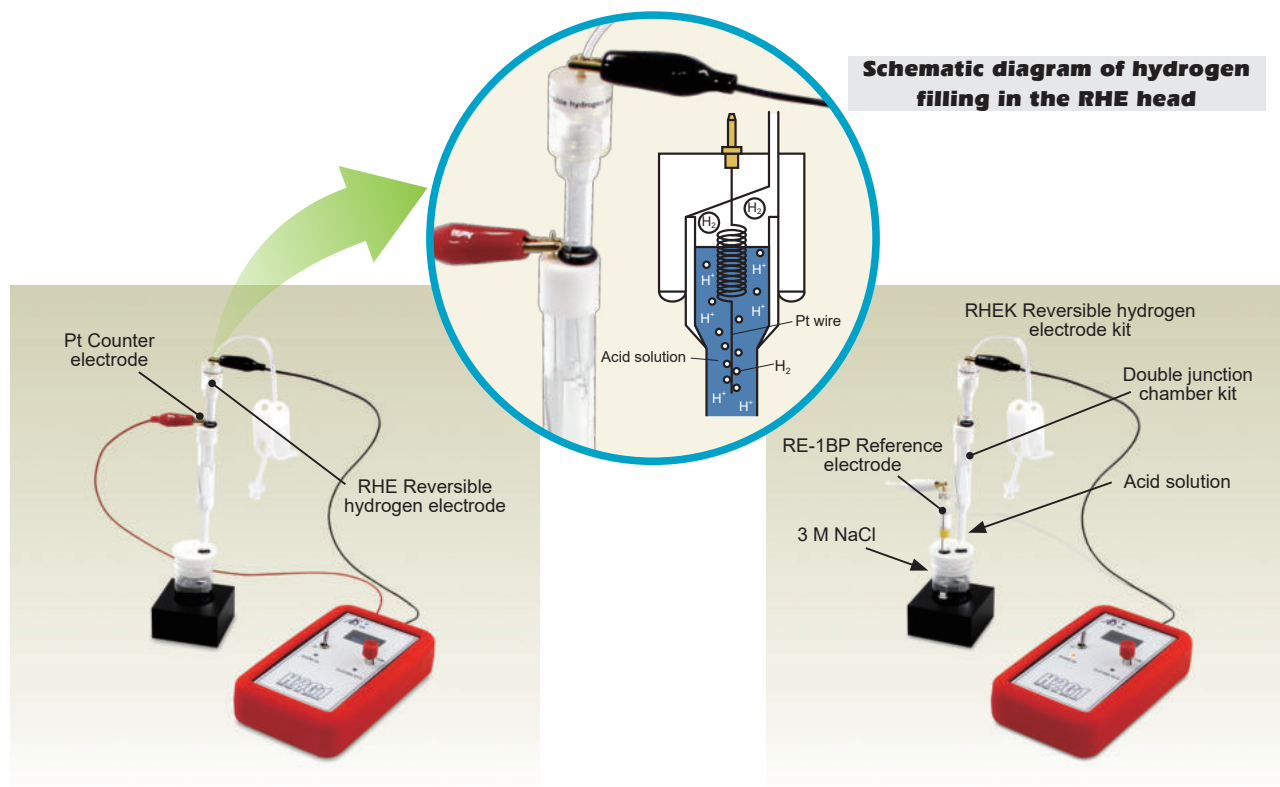

Schematic diagram of hydrogen filling in the RHE head

1. Electrolytic hydrogen generation function

2. Potential measurement auxiliary Function (*)

* The potential measurement mode is an auxiliary function, for an accurate electrode potential measurement, an appropriate device is recommended. Also note that the reference electrode using an internal solution with high resistance, such as saturated K_2SO_4 solution, will increase the deviation.

2

Reference Electrodes

Reference electrodes are widely used for electrochemical measurements (CV, LSV, DPV, etc.) and electrochemical devices (electrochemical detection for HPLC, electrochemical biosensor, etc.). Various kinds of them such as aqueous, non-aqueous, calomel and own-constructing types are available.

Reversible Hydrogen Electrode

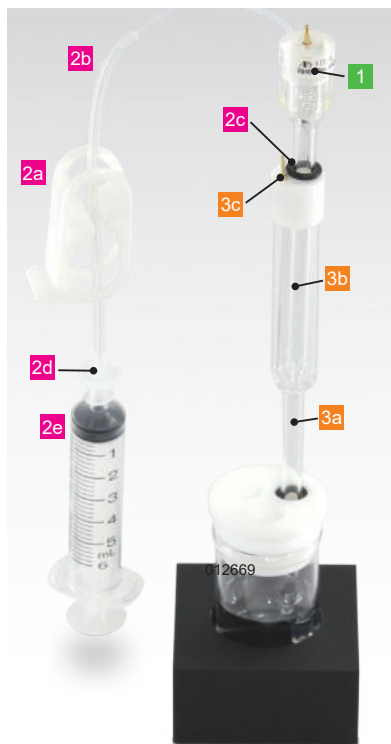

001209

001209 Cell holder for 20 mL vial and 012669 SVC-3 Voltammetry cell are sold separately.

RHE is a reversible electrode kit, in which hydrogen gas is generated by electrolysis of strong acid then stored. It makes unnecessary the complicated and dangerous set-up of the hydrogen cylinder and avoids the large volume of hydrogen gas exhaustion, despite that it has a good potential stability.

Catalog No.	Description		
013597	RHEK Reversible hydrogen electrode kit		
Contents			Qty
1	013598	RHE Reversible hydrogen electrode	1
2	013378	RHEK accessories kit	1
2a	(Content)	Tubing clamp	1
2b		Silicone tube (10 cm)	3
2c		O-ring	1
2d		Female lure fitting	1
2e		Disposable syringe	1

Catalog No.	Description		
3	Double junction chamber kit		
Contents			Qty
3a	013376	Double junction chamber	1
3b	013377	PTFE Cap for double junction chamber	1
3c	002222	Platinum counter electrode 5.7 cm	1



ALS support product manual
<https://www.als-japan.com/support-product-manual.html>
[Manual download link](#)

Contents & structure

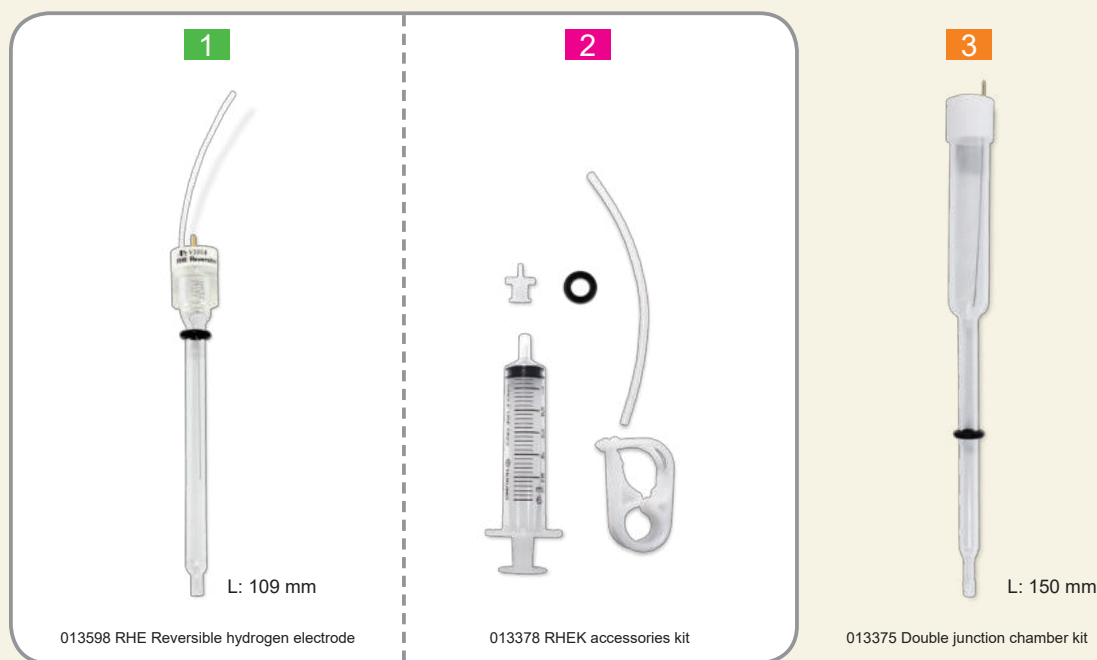

013597 RHEK Reversible hydrogen electrode kit

* "L" is an approximately length

For Aqueous solution

Ag/AgCl type

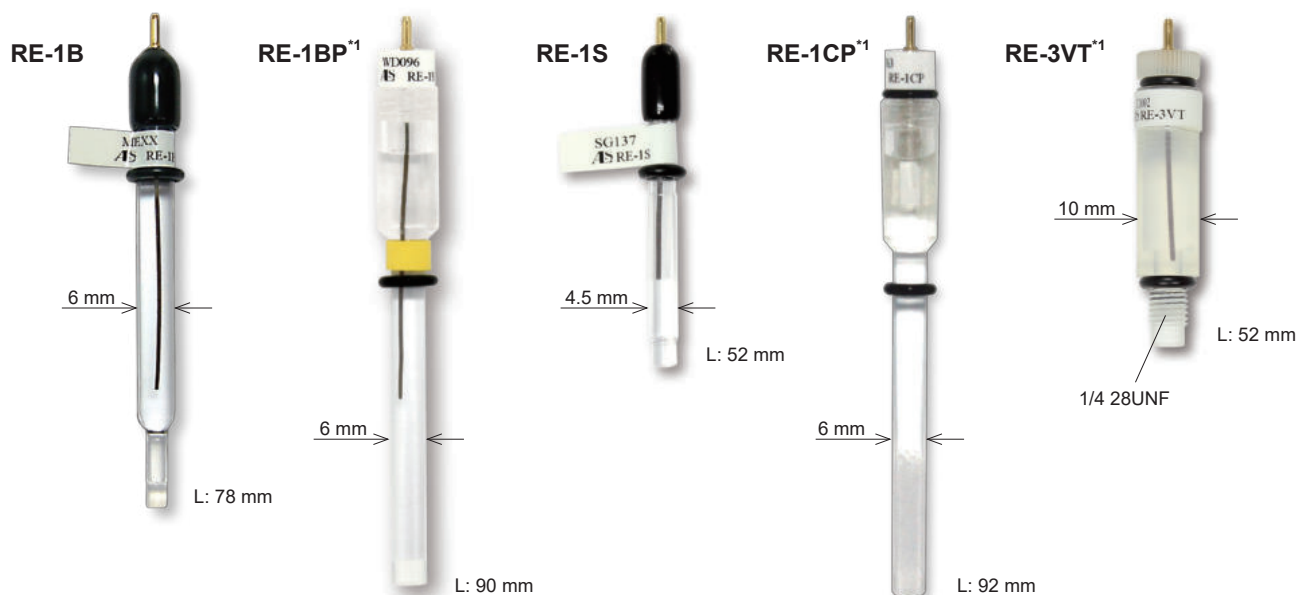

* "L" is an approximately length

RE-1B Reference potential^{*2}

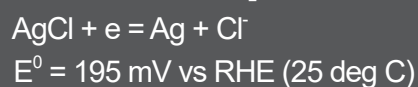

Feature

- For application in an aqueous solution
- Relatively long life time

RE-1BP Reference potential^{*2}

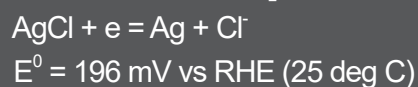

RE-1CP Reference potential^{*2}

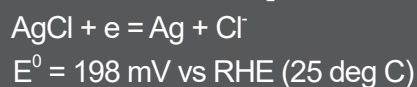

Catalog No.	Description	Junction	Electrolyte	Purpose
012167	RE-1B Reference electrode (Ag/AgCl)	IPPG ^{*3}	3 M NaCl	SVC-2, SVC-3, VC-4, Bulk electrolysis, RRDE, EQCM
013613	RE-1BP Reference electrode (Ag/AgCl)	Ceramics	3 M NaCl	SVC-2, SVC-3, VC-4, Bulk electrolysis, RRDE, EQCM
013393	RE-1S Reference electrode (Ag/AgCl)	IPPG ^{*3}	3 M NaCl	SECM
013691	RE-1CP Reference electrode (Ag/AgCl/Saturated KCl)	Ceramics	saturated KCl	SVC-2, SVC-3, VC-4, Bulk electrolysis, RRDE, EQCM
013488	RE-3VT Reference electrode screw type (Ag/AgCl)	Ceramics	3 M NaCl	For Flow cell (LC, EQCM, SEC-3F)

*1. Polymethyl pentene

*2. The reference potential mentioned for each reference electrode is the measured value using RHEK reversible hydrogen electrode kit (Cat. No.013597).

*3. IPPG: Ion Permeability Porous Glass



ALS support product manual
<https://www.als-japan.com/support-product-manual.html>
Manual download link



INSPECTED
<https://www.als-japan.com/dl/>
Inspection data sheet link

Hg type

RE-2BP^{*1}



RE-2CP^{*1}



RE-61AP^{*1}



* "L" is an approximately length

RE-2BP Reference potential^{*2}

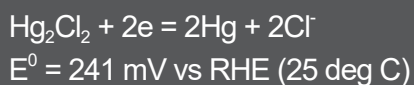

Feature

- Internal solution can be replaced

RE-2CP Reference potential^{*2}

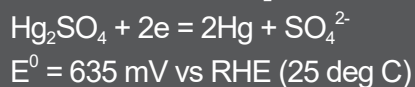

RE-61AP Reference potential^{*2}

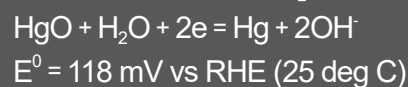

Catalog No.	Description	Junction	Electrolyte	Purpose
013693	RE-2BP Calomel reference electrode	Ceramics	Saturated KCl	For application as a standard reference electrode
013692	RE-2CP Reference electrode	Ceramics	Saturated K ₂ SO ₄	For application as a free from chloride ion measurement
013694	RE-61AP Reference electrode	Ceramics	-	For application in an alkaline solution

*1. Polymethyl pentene

*2. The reference potential mentioned for each reference electrode is the measured value using RHEK reversible hydrogen electrode kit (Cat. No.013597).

The reference electrode can be selected depending on the sample to be measured. The following is a table of recommended pH ranges for reference electrode line up.

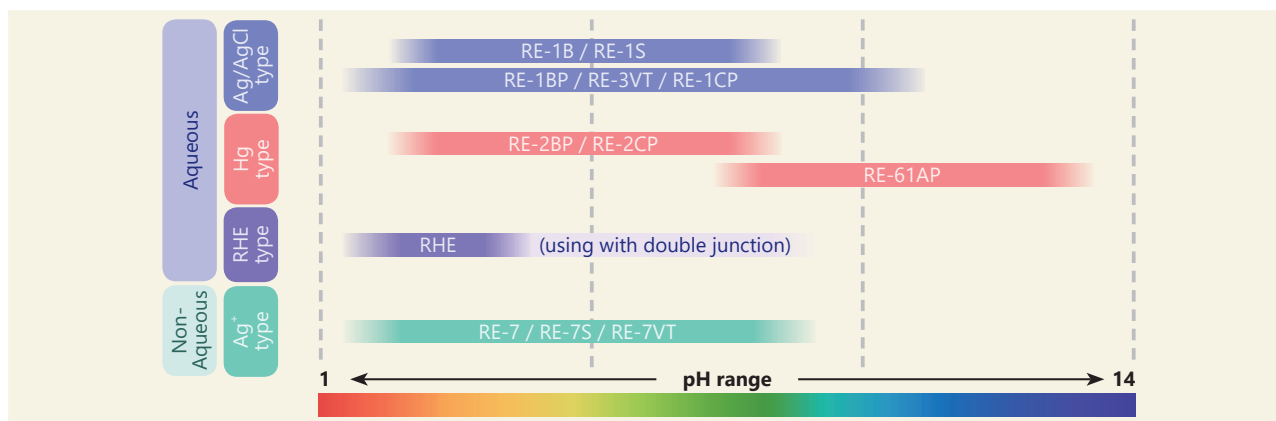

For Non Aqueous solution

Ag/Ag⁺ type

RE-7

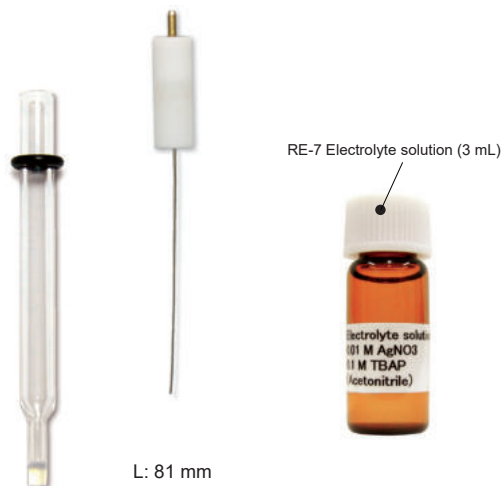

L: 81 mm

RE-7S

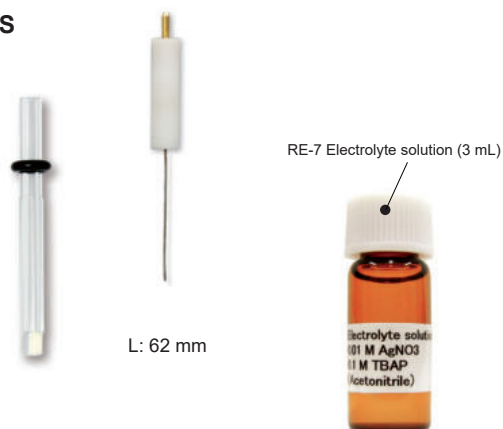

L: 62 mm

RE-7VT^{*1}

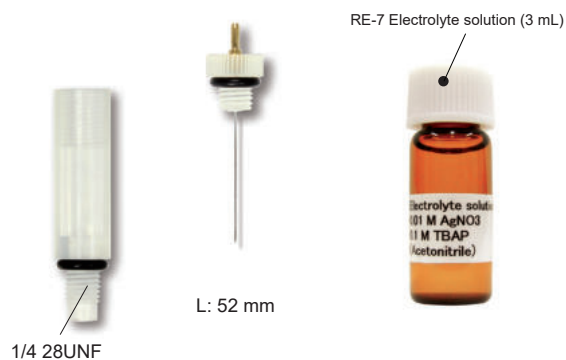

L: 52 mm

1/4 28UNF

* "L" is an approximately length

Feature

- For application in an organic solvent based samples
- Internal solution can be replaced



ALS support product manual
<https://www.als-japan.com/support-product-manual.html>
Manual download link

Catalog No.	Description	Junction	Electrolyte	Purpose
012171	RE-7 Non Aqueous reference electrode (Ag/Ag ⁺)	IPPG ^{*2}	ACN/TBAP ^{*3}	SVC-2, SVC-3, VC-4, Bulk electrolysis, RRDE, EQCM
013394	RE-7S Non Aqueous reference electrode (Ag/Ag ⁺)	IPPG ^{*2}	ACN/TBAP ^{*3}	SECM
013489	RE-7VT Non Aqueous reference electrode (Ag/Ag ⁺)	Ceramics	ACN/TBAP ^{*3}	For Flow cell (LC, EQCM, SEC-3F)
Optional items (sold separately)				
012549	RE-7 Electrolyte solution (10mL)		ACN/TBAP ^{*3}	For refill of RE-7 line up (about 15 times)
012108	RE-PV Preservative vial for reference electrode			For preservation of OD 6.0 mm reference electrode
012057	RE-7 Teflon cap with Ag wire			With Ag wire
012058	RE-7S Teflon cap with Ag wire			With Ag wire
012176	Sample holder dia 6mm (2pcs)			For double junction, manufacturing of the electrode

*1. Polymethyl pentene *2. IPPG: Ion Permeability Porous Glass *3. ACN: acetonitrile
 TBAP: tetrabutylammonium perchlorate

Technical note

Supporting electrolyte

If the sample is dissolved in an organic solvent, the supporting electrolyte must be added. In order to select the supporting electrolyte, it is necessary to consider the following:

1. Solubility in organic solvents
2. Wide potential window
3. No reaction with organic solvent

Typical supporting electrolyte:

TEAP: Tetraethylammonium perchlorate

TBAPF6: Tetrabutylammonium hexafluorophosphate

Sample Holder & Accessories

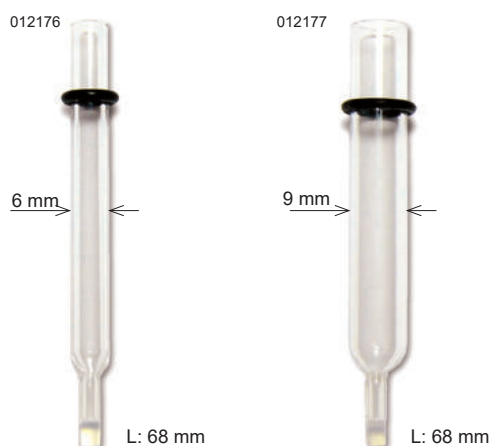

These products enable to take electrochemical measurement by only 200 μ L sample volume. A IPPG* tip is attached to the end of its glass tube, and ions transmit freely. The sample holder is a multi-purpose accessory.

- 6 mm diameter holders can be used for RE-7 series reference electrode
- 9 mm diameter can be used in SVC-2 voltammetry cell
- Can be used as a salt bridge, in which a reference electrode is installed in order to prevent contamination.

Catalog No.	Description
012176	Sample holder dia 6.0 mm (2 pcs)
012306	Sample holder dia 6.0 mm (22 pcs)
012177	Sample holder dia 9.0 mm (2 pcs)
012307	Sample holder dia 9.0 mm (22 pcs)

*IPPG (Ion Permeability Porous Glass) is a porous glass with 40-200 \AA diameter of pores. Chemically stable, operational as high as 800 $^{\circ}\text{C}$. Also can be cut with a sharp knife.

Reminder:

Yellowish discoloration indicates contamination. This is caused by the absorbing of organics into their pores from air.

Catalog No.	Description
012796	Repair kit for Sample holder*

* Contents: Heat shrink Teflon tubing, 150 mm
IPPG Rod, dia 3.2 x 4.0 mm, 10 pcs

Preservative vial



* Reference electrode is sold separately.

If purchased or self-prepared reference electrode is left in direct contact with air, the inside solution will evaporate and dry up gradually. When it is not in use, a recommended way, in order to maintain the reference electrode capability and life time, is to preserve in a sealed preservative bottle with a solution, similar to the reference electrode internal solution.

For example:

3 M NaCl for the preservation of the RE-1B Reference electrode.

Catalog No.	Description	Qty
012108	RE-PV Preservative vial for reference electrode	
Contents		
011987	Teflon cap for RE-PV	1
-----	Screw vial 10 mL	1
Optional item		
012549	RE-7 Electrolyte solution (10 mL)	

Ag/AgCl Ink for Reference electrode



Reference electrodes can be easily prepared by coating Ag/AgCl ink on the metal (Ag, Pt, Au, etc.) surface. The only thing you are required to do is just to deposit the Ag/AgCl ink and wait for dry. The reference electrode prepared by Ag/AgCl ink is quite useful for IDA electrode measurements.

Catalog No.	Description
011464	Ag/AgCl Ink for reference electrode (2.0 mL)
Specification	
Surface resistance	0.2 Ω /sq/25.4 μm
Viscosity	50 \pm 10 Pa·s @21.1 deg C
Flash point	82 deg C

3

Working Electrodes

General Working Electrodes for Voltammetry

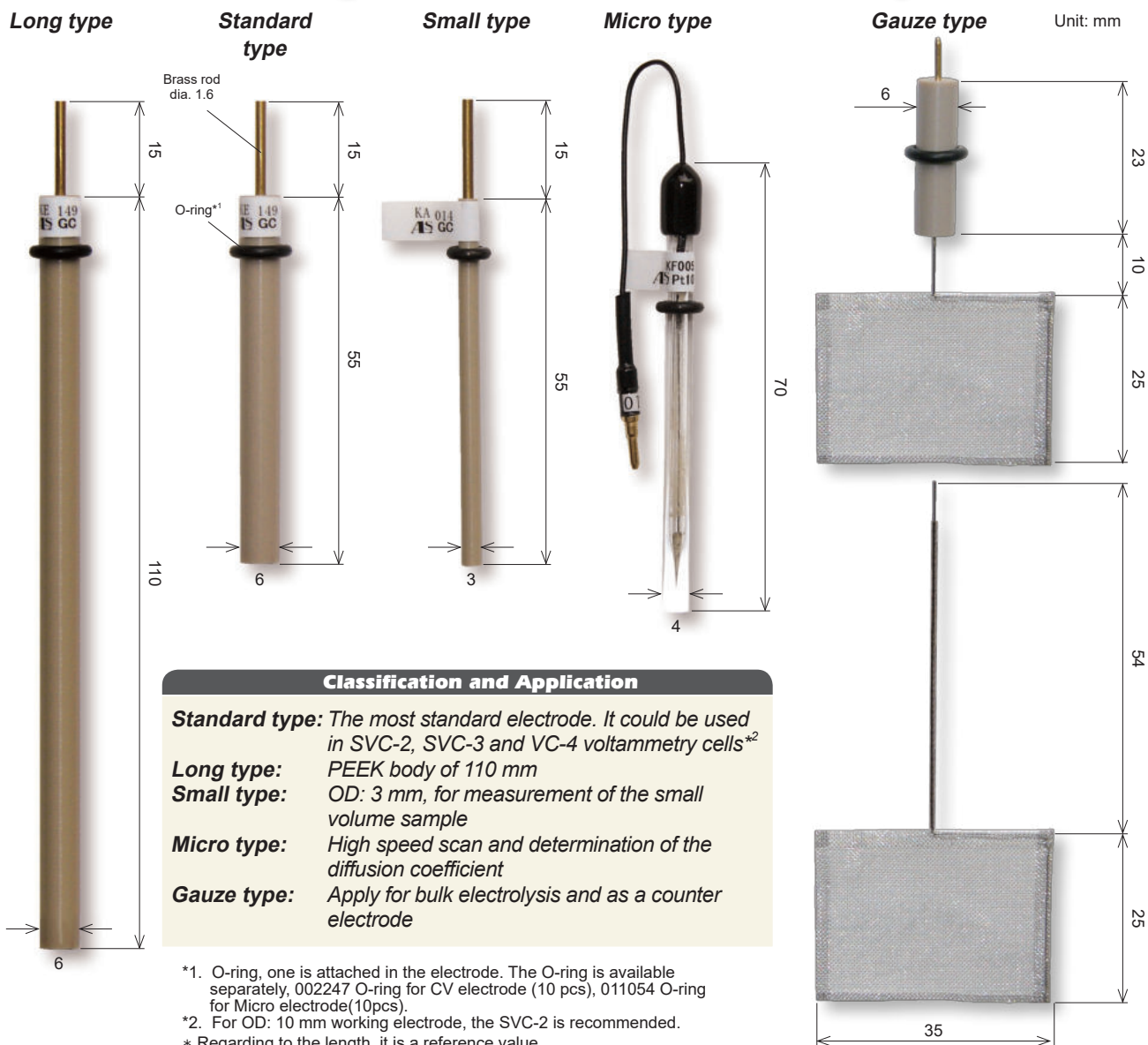

Classification and Application

Standard type: The most standard electrode. It could be used in SVC-2, SVC-3 and VC-4 voltammetry cells*2

Long type: PEEK body of 110 mm

Small type: OD: 3 mm, for measurement of the small volume sample

Micro type: High speed scan and determination of the diffusion coefficient

Gauze type: Apply for bulk electrolysis and as a counter electrode

*1. O-ring, one is attached in the electrode. The O-ring is available separately, 002247 O-ring for CV electrode (10 pcs), 011054 O-ring for Micro electrode (10 pcs).

*2. For OD: 10 mm working electrode, the SVC-2 is recommended.

* Regarding to the length, it is a reference value.

CPO Carbon Pasete Oil



Carbon Paste Oil (CPO) is prepared by mixing uniform-sized graphite powder and paraffin oil. This product is applied to Carbon Paste Electrode to have:

- 1) simple enzyme electrodes
- 2) chemically modified electrodes

It could not be used in an organic solvent. Keep the container closed to avoid contamination.

How to prepare carbon paste electrode:

- 1) Mix and homogenize the compound to be analyzed in the CPO
- 2) Fill tightly into the electrode hole with a small spatula
- 3) Remove the excess CPO and polish the surface of the electrode with circular movement on the clean paper

Catalog No.	Description
001010	CPO Carbon paste oil base (1 g)

Full Listing of Working Electrodes

Catalog No.	Description	Isolation	Specification	
002250	Platinum gauze electrode	PEEK	80 mesh	35×25 mm
012619	Platinum gauze electrode, lead wire 54 mm	-	80 mesh	35×25 mm
002251	Gold gauze electrode	PEEK	100 mesh	35×25 mm
002417	GCE Glassy carbon electrode	PEEK	OD: 10 mm	ID: 5 mm
012744	LGCE Glassy carbon electrode	PEEK	OD: 6 mm	ID: 3 mm
002012	GCE Glassy carbon electrode	PEEK	OD: 6 mm	ID: 3 mm
012297	GCE Glassy carbon electrode	PEEK	OD: 6 mm	ID: 1.6 mm
002411	GCE Glassy carbon electrode	PEEK	OD: 6 mm	ID: 1 mm
012298	SGCE Glassy carbon electrode	PEEK	OD: 3 mm	ID: 1.6 mm
002412	SGCE Glassy carbon electrode	PEEK	OD: 3 mm	ID: 1 mm
002002	MCE Micro Carbon fiber electrode	Glass	OD: 4 mm	ID: 33 μm
002007	MCE Micro Carbon fiber electrode	Glass	OD: 4 mm	ID: 7 μm
002418	AUE Gold electrode	PEEK	OD: 10 mm	ID: 5 mm
012746	LAUE Gold electrode	PEEK	OD: 6 mm	ID: 3 mm
002421	AUE Gold electrode	PEEK	OD: 6 mm	ID: 3 mm
002014	AUE Gold electrode	PEEK	OD: 6 mm	ID: 1.6 mm
002314	SAUE Gold electrode	PEEK	OD: 3 mm	ID: 1.6 mm
002010	MAUE Micro Gold electrode	Glass	OD: 4 mm	ID: 100 μm
002004	MAUE Micro Gold electrode	Glass	OD: 4 mm	ID: 25 μm
002006	MAUE Micro Gold electrode	Glass	OD: 4 mm	ID: 10 μm
002420	PTE Platinum electrode	PEEK	OD: 10 mm	ID: 5 mm
012745	LPTE Platinum electrode	PEEK	OD: 6 mm	ID: 3 mm
002422	PTE Platinum electrode	PEEK	OD: 6 mm	ID: 3 mm
002013	PTE Platinum electrode	PEEK	OD: 6 mm	ID: 1.6 mm
002313	SPTE Platinum electrode	PEEK	OD: 3 mm	ID: 1.6 mm
002009	MPTE Micro Platinum electrode	Glass	OD: 4 mm	ID: 100 μm
002003	MPTE Micro Platinum electrode	Glass	OD: 4 mm	ID: 25 μm
002015	MPTE Micro Platinum electrode	Glass	OD: 4 mm	ID: 15 μm
002005	MPTE Micro Platinum electrode	Glass	OD: 4 mm	ID: 10 μm
002416	AGE Silver electrode	PEEK	OD: 10 mm	ID: 5 mm
002419	AGE Silver electrode	PEEK	OD: 6 mm	ID: 3 mm
002011	AGE Silver electrode	PEEK	OD: 6 mm	ID: 1.6 mm
002315	SAGE Silver electrode	PEEK	OD: 3 mm	ID: 1.6 mm
002016	NIE Nickel electrode	PEEK	OD: 6 mm	ID: 1.5 mm
002273	MNIE Micro Nickel electrode	Glass	OD: 4 mm	ID: 100 μm
002252	PGBE Pyrolytic graphite electrode (Basal Plane)	PEEK	OD: 6 mm	ID: 3 mm
002253	PGEE Pyrolytic graphite electrode (Edge Plane)	PEEK	OD: 6 mm	ID: 3 mm
002408	PFCE 3 Carbon electrode *1	PEEK	OD: 6 mm	ID: 3 mm
002409	PFCE 1 Carbon electrode *1	PEEK	OD: 6 mm	ID: 1 mm
011854	SPFCE 1 Carbon electrode *1	PEEK	OD: 3 mm	ID: 1 mm
002019	PDE Palladium electrode	PEEK	OD: 6 mm	ID: 1.6 mm
002319	SPDE Palladium electrode	PEEK	OD: 3 mm	ID: 1.6 mm
012585	FEE Iron electrode	PEEK	OD: 6 mm	ID: 3 mm
002018	FEE Iron electrode	PEEK	OD: 6 mm	ID: 1.5 mm
012584	CUE Copper electrode	PEEK	OD: 6 mm	ID: 3 mm
002017	CUE Copper electrode	PEEK	OD: 6 mm	ID: 1.6 mm
002271	MCUE Micro Copper electrode	Glass	OD: 4 mm	ID: 25 μm
002272	MWE Micro Tungsten electrode	Glass	OD: 4 mm	ID: 10 μm
002210	CPE Carbon paste electrode *2	PEEK	OD: 6 mm	ID: 3 mm
002223	SCPE Carbon paste electrode *2	PEEK	OD: 3 mm	ID: 1.6 mm

Customized electrode is also available

*1. Plastic Formed Carbon Electrode (PFCE) is created from a collaboration of MITSUBISHI PENCIL CO., LTD and National Institute of Advanced Industrial Science and Technology (AIST).

*2. 001010 CPO Carbon paste oil base (1 g) is sold separately (p. 9). Note that the carbon paste is not filled up.



ALS support product manual
<https://www.als-japan.com/support-product-manual.html>
Manual download link



INSPECTED
<https://www.als-japan.com/dl/>
Inspection data sheet link

Lithography / Glass substrate Electrodes

Ring-Disk electrode

This ring-disk type electrode developed by NTT-AT is one type of printed electrodes. Users can choose Carbon, Gold and Platinum as a working electrode, use for radial flow cells, and achieve complete reduction/oxidation on the center disk at micro flow rate because of its fine coulometric electrolysis efficiency. This also enables to analyze subsequent reaction as well as identification and quantitation of the sample at the same time. Furthermore, this electrode becomes capable of measuring hydrogen peroxide at zero volt by immobilized Osmium Gel / Horse Radish Peroxidase (HRP) (developed by Prof. Adam Heller, Texas Univ.). Thus this Printed electrode comprises FIA (Flow Injection Analysis) system with combinations of various enzymes.

Catalog No.	Description
002081	Gold ring disk electrode (3 pcs)
002082	Platinum ring disk electrode (3 pcs)
002083	Carbon ring disk electrode (3 pcs)

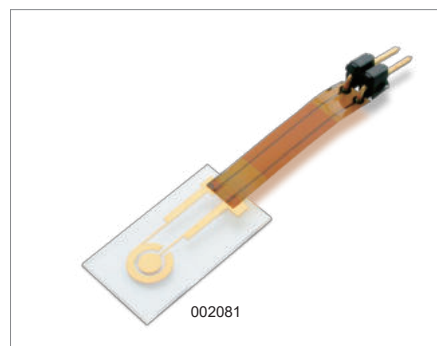

Size: 12.5 x 22 x 0.5 mm

Conductivity electrode

Platinum terminals are deposited on a fused quartz substrate as current supplying electrodes and potential difference probing electrodes. The distance between electrodes for potential difference are adjustable from 40 μm to 250 μm by changing the connect terminals.

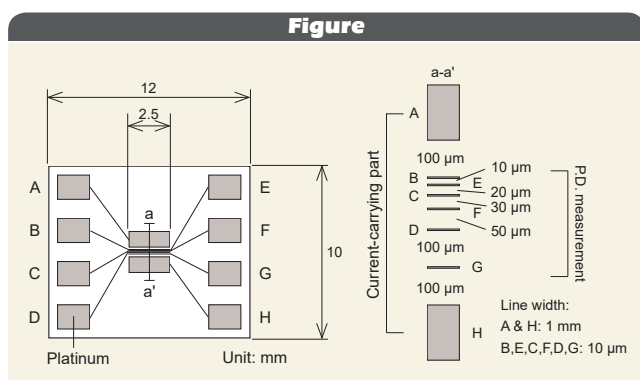
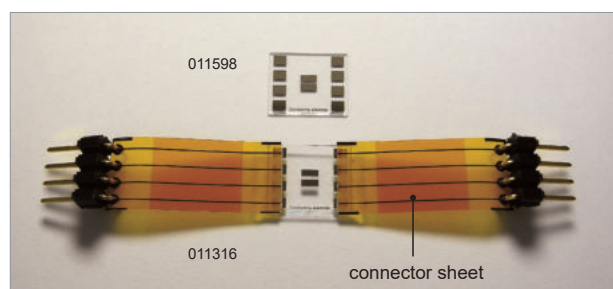

Interval

Point	Interval					
	B	C	D	E	F	G
B		40	140	10	80	250
C	40		90	20	30	200
D	140	90		120	50	100
E	10	20	120		60	230
F	80	30	50	60		160
G	250	200	100	230	160	

Unit: μm

Catalog No.	Description	Specification
011316	Conductivity electrode	With connector sheet*
011598	Conductivity electrode (3 pcs)	Without connector sheet

*The following connector is convenient for connection of the electrode with the connector sheet.

- 011839 Connector for printed electrodes
- 011840 IC clip for printed electrodes (4 pcs)

IDA electrode

Interdigitated Array (IDA) electrode is an electrode developed for electrochemical measurements to be performed in a very small quantity of the sample. IDA electrode could be applied for the detection and reaction analysis of the compounds in a small quantity of the sample. IDA electrode is a microelectrode pattern fabricated by using the lithography technology. The electrodes are composed of 65 pairs. In each one of the pair has a function of the oxidation and reduction electrodes.

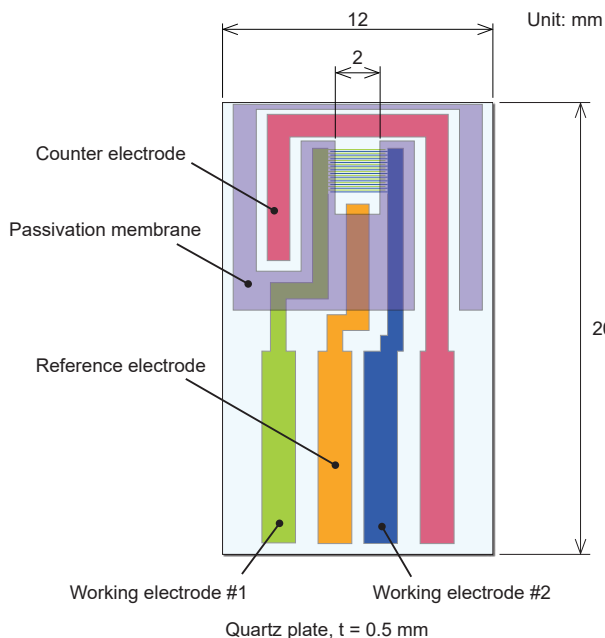

Feature

- High sensitivity CV measurement
- Electrochemical measurements in a small quantity of the sample
- Small integration
- High-speed response

Application

- Electrochemical measurements
- Conductivity measurement
- Biosensor/chemical sensor
- Chemically modified electrode
- Chemical reaction process control



ALS support product manual
<https://www.als-japan.com/support-product-manual.html>
Manual download link

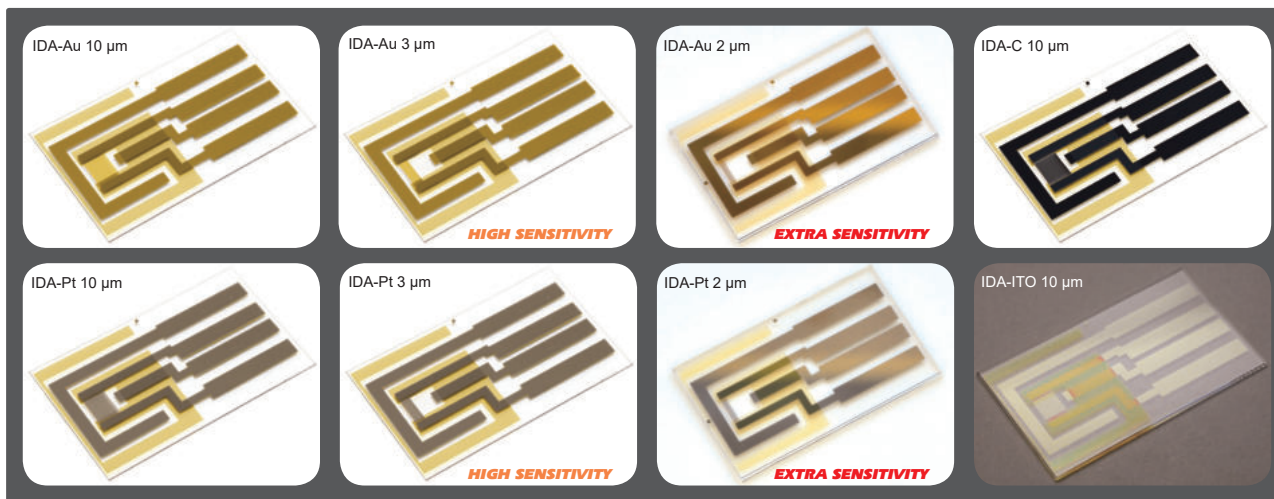

Catalog No.	Description	Specification				
		Width (μm)	Interval (μm)	Length (mm)	pairs	Film thickness
012125	IDA electrode (Au) 10 μm	10	5	2	65	90 nm*
012126	IDA electrode (Pt) 10 μm	10	5	2	65	90 nm*
012127	IDA electrode (Carbon) 10 μm	10	5	2	65	1.2 ± 0.1 μm
012128	IDA electrode (ITO) 10 μm	10	5	2	65	100 ± 20 nm
012129	IDA electrode (Au) 3 μm	3	3	2	65	90 nm*
012130	IDA electrode (Pt) 3 μm	3	3	2	65	90 nm*
012257	IDA electrode (Au) 2 μm	2	2	2	65	90 nm*
012258	IDA electrode (Pt) 2 μm	2	2	2	65	90 nm*
011066	Cable kit for IDA electrode					
011464	Ag/AgCl Ink for reference electrode (2.0 mL)					

* For Au and Pt, the thickness of the titanium adhesive layer is about 10 nm, resulting in a total thickness of 100 nm.

Working Electrodes

IDA electrode w/o passivation membrane

There is a method for the calculation of the dielectric constant from the capacitance measured from the current intensity by the application of the alternative potential through the IDA electrode. However, for an IDA electrode with a passivation membrane, the capacitance of the membrane is also measured, making impossible to obtain the exact measured value. For this purpose, IDA electrode without passivation membrane was added to the product lineup.

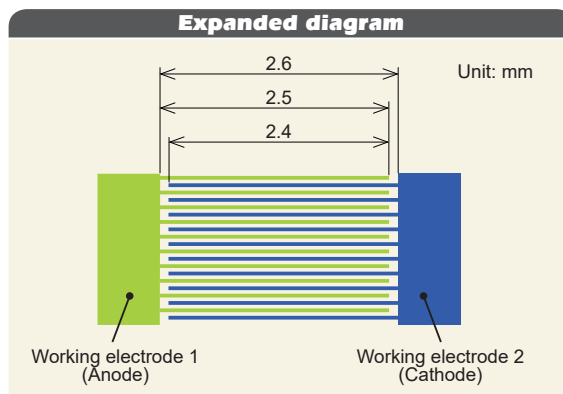

Catalog No.	Description	Specification				
		Width (μm)	Interval (μm)	Length (mm)	pairs	Film thickness
012259	IDA electrode (Au) 10 μm without passivation membrane	10	5	2.5	65	90 nm*
012262	IDA electrode (Pt) 10 μm without passivation membrane	10	5	2.5	65	90 nm*
012266	IDA electrode (Carbon) 10 μm without passivation membrane	10	5	2.5	65	1.2 ± 0.1 μm
012265	IDA electrode (ITO) 10 μm without passivation membrane	10	5	2.5	65	100 ± 20 nm
012260	IDA electrode (Au) 3 μm without passivation membrane	3	3	2.5	65	90 nm*
012263	IDA electrode (Pt) 3 μm without passivation membrane	3	3	2.5	65	90 nm*
012261	IDA electrode (Au) 2 μm without passivation membrane	2	2	2.5	65	90 nm*
012264	IDA electrode (Pt) 2 μm without passivation membrane	2	2	2.5	65	90 nm*

* For Au and Pt, the thickness of the titanium adhesive layer is about 10 nm, resulting in a total thickness of 100 nm.

Cable kit for IDA electrode

The Cable kit is the most suitable connector for IDA electrode. Be careful when you are inserting or removing the IDA electrode, it consists of quartz glass and it can break easily.

- 1) Put the IDA electrode into the connector
- 2) Insert the Teflon fixer into the connector



ALS IDA cable kit movie
<https://www.als-japan.com/1681.html>
 Support Movie link

Catalog No.	Description	Qty
011066	Cable kit for IDA electrode	
Contents		
012970	Electrode Fixer (Teflon plate)	1
	Mini vice	1
	Connecting cable	1

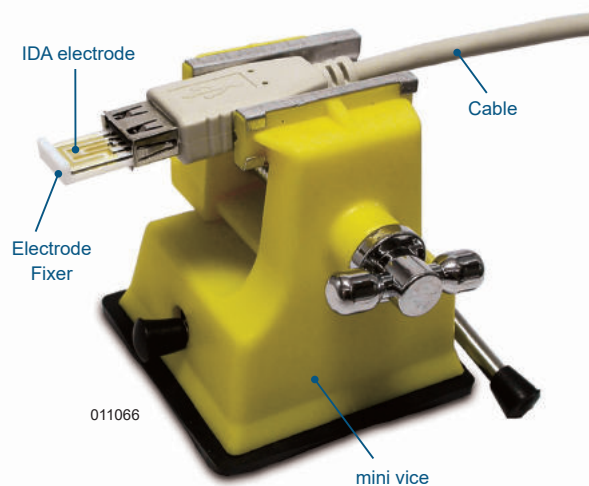

4

Counter Electrodes

Four different shapes of the counter electrodes are available. Select the counter electrodes suitable for the experimental conditions. Custom-made counter electrode is also available.

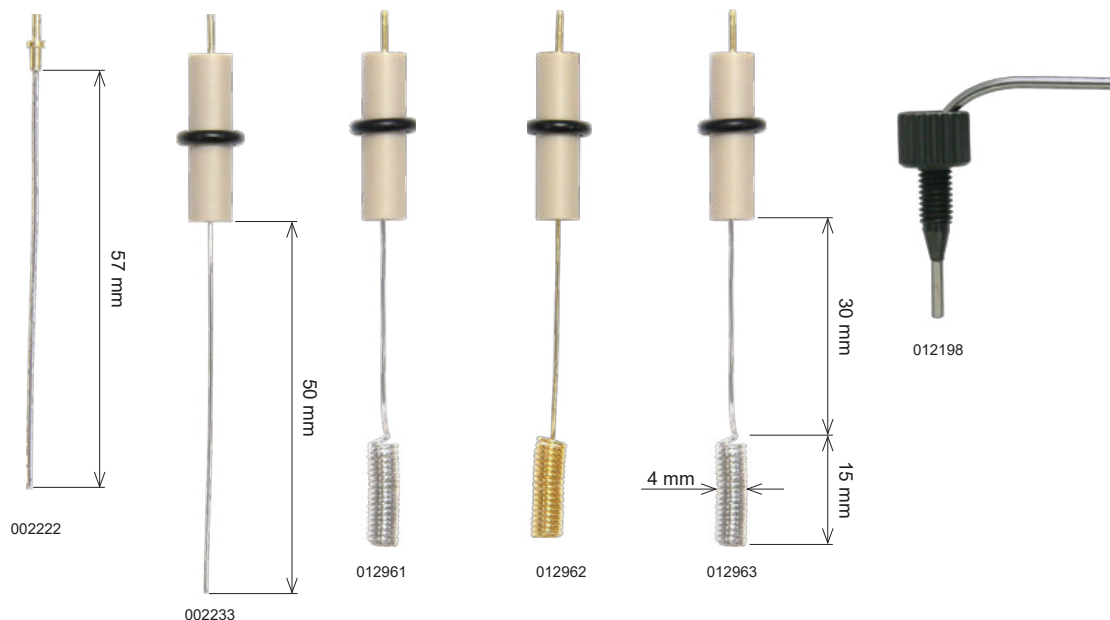

Catalog No.	Description	Purpose
002222	Platinum counter electrode 5.7 cm	SVC-2, VC-4, Plate Material Evaluating cell
002233	Platinum counter electrode 5 cm	SVC-3
012961	Platinum counter electrode 23 cm	RRDE, Bulk electrolysis, SVC-3
012962	Gold counter electrode 23 cm	RRDE, Bulk electrolysis, SVC-3
012963	Nickel counter electrode 23 cm	RRDE, Bulk electrolysis, SVC-3
012198	Counter electrode for Flow cell	Stainless steel pipe, for Flow cell (LC, EQCM, SEC-3F)

Technical note

The role of Counter electrode

For a system using three-electrode potentiostat, we measure current when a potential is applied between the working electrode and the reference electrode. Passage of current through an electrical circuit requires electron transfer reaction between the working electrode and the counter electrode. The main function of the counter electrode is to support a second electron transfer reaction. Important parameter of the counter electrode is the surface area. It is required (area) large enough to support the current generated for the working electrode. For example, the surface area of the platinum electrode of 5 cm length is sufficient to use as a micro-working electrode, such as steady-state cyclic voltammetry experiments. However, for generating a high current measurements such as bulk electrolysis, the counter electrode of a larger area is required, as Catalog No.012961 which the length of platinum is 23 cm. This electrode is used for measurement, such as rotating ring disk.

The cell shape is also an important point. For the electrolysis, to avoid the contamination of the product from the counter electrode, it is arranging separately, isolated in a chamber, from the working electrode. For electrochemical measurements such as cyclic voltammetry, because of the short measurement time, you can ignore the effects of contamination by electrolysis. Therefore, it is not usual the isolation of the counter electrode. In some cases, the separation of the counter electrode in a chamber increases the resistance between counter electrode and reference electrode, under the influence of (sintered glass) frit. However, in the case of bulk electrolysis, because of long measurement time, the agitation and separation of the working electrode and counter electrode using a chamber is necessary, to prevent the transportation between two electrodes.

5

Voltammetry Cells

SVC-2 Voltammetry cell

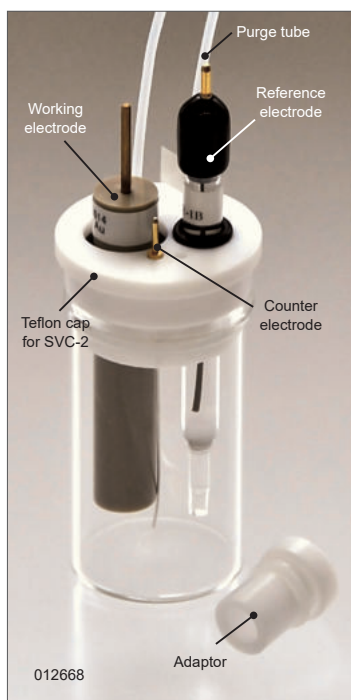

Working electrode and reference electrode are sold separately. Each component could be purchased separately. For acquisition separately, the sample vial of 20 mL is composed for 10 pieces.

Multi purpose cell - 4 modes setting

SVC-2 Voltammetry cell can be used for 4 modes voltammetry cell setup. Also, it can be applied as an oxygen-free voltammetry cell. Setting the sample holder of 9.0 mm of the diameter, it enable small sample measurement (100 - 200 μ L).

Features and location of Teflon cap holes

- For various types of electrodes
- Sample volume from 5 to 10 mL
(For very small quantity measurement*, from 100 to 200 μ L)
- Easy removal of the dissolved oxygen

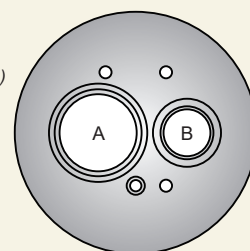

- A** : for OD 9, 10 mm electrode
- B** : for OD 4, 6 mm electrode
- Adaptor** : for OD 6 mm electrode

* 012177 Sample holder dia 9 mm is required separately.

Catalog No.	Description	Qty
012668	SVC-2 Voltammetry cell	
Contents		
(001056)	Sample vial (20 mL)	7
002222	Platinum counter electrode 5.7 cm	1
012670	Teflon cap for SVC-2	1
(010537)	Purge tube (ETFE), 30 cm	1
Optional item		
012177	Sample holder dia 9.0 mm (2 pcs)	

4 mode measurement setting

Standard

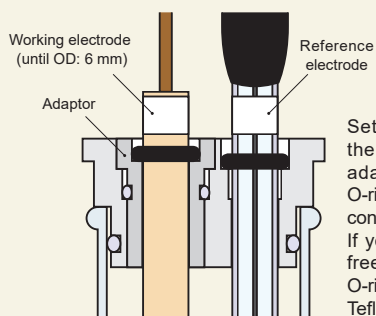

Set the Teflon cap adaptor to the Teflon cap. The Teflon cap adaptor is fixed with a silicon O-ring to work in an oxygen-free condition. If you do not need the oxygen-free condition, then the silicon O-ring can be taken out from the Teflon cap.

10 mm dia WE

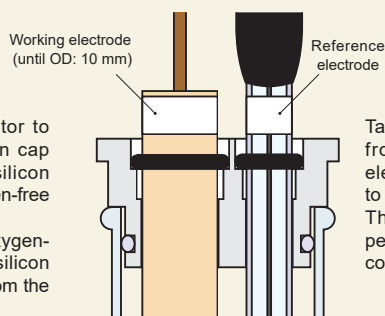

Take out the Teflon cap adaptor from the Teflon cap. Working electrode can be fitted directly to the Teflon cap. The O-ring will fit perfectly. It permits to have the oxygen-free condition.

Small sample

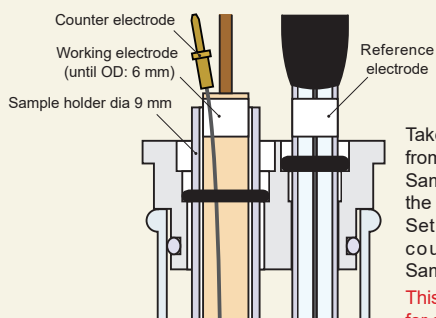

Take out the Teflon cap adaptor from the Teflon cap, and set the Sample holder of the 9.0 mm of the diameter (optional item). Set the working electrode and counter electrode into the Sample holder.

This configuration is not adaptive for oxygen free experiment.

Low temperature

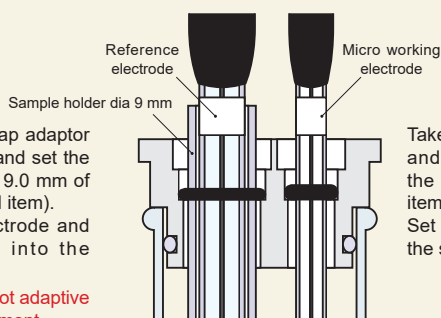

Take out the Teflon cap adaptor, and set the Sample holder of the 9.0 mm diameter (optional item). Set the reference electrode into the sample holder.

SVC-3 Voltammetry cell

Standard voltammetry cell



- Sample volume from 5 to 10 mL
- For various types of electrode
- Easy removal of the dissolved oxygen

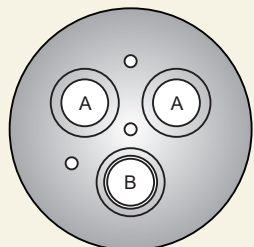

A : for OD 6 mm electrode
B : for OD 4, 6 mm electrode

012669

Reference electrode is sold separately.

Catalog No.	Description	Qty
012669	SVC-3 Voltammetry cell	
Contents		Qty
(001056)	Sample vial (20 mL)	7
002233	Platinum counter electrode 5 cm	1
012671	Teflon cap for SVC-3	1
(010537)	Purge tube (ETFE), 30 cm	1
Optional item		
012961	Platinum counter electrode 23 cm	
012963	Nickel counter electrode 23 cm	

Plate Material Evaluating cell

Evaluation of plate material

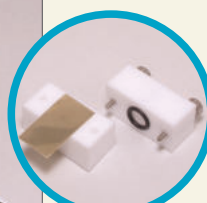

This quite handy cell was developed in order to evaluate a plate material such as metal, semi-conducting plate, etc.

011951

Reference electrode is sold separately.

Catalog No.	Description	Qty
011951	Plate Material Evaluating Cell	
Contents		Qty
	Teflon Cell [Body]	1
	Teflon Cell [Base]	1
	Teflon cap	1
	O-ring (Viton)	1
	Screw 20 mm	2
002222	Platinum counter electrode 5.7 cm	1
(010537)	Purge tube (ETFE), 30 cm	1

VC-4 Voltammetry cell

Small sample measurement cell



- Sample volume from 1 to 3 mL
- Including specific cell holder
- Fit the standard type (6 mm)

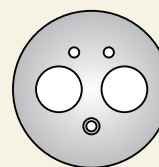

011224

Reference electrode is sold separately.

Catalog No.	Description	Qty
011224	VC-4 Voltammetry cell	
Contents		Qty
(011504)	Sample vial (5 mL)	7
002222	Platinum counter electrode 5.7 cm	1
011226	Teflon cap for VC-4	1
011227	Cell holder for 5 mL vial	1
(010537)	Purge tube (ETFE), 30 cm	1

Bulk Electrolysis cell

High current complete electrolysis of the target component



Bulk electrolysis cell is used for complete electrolysis of solution. Typical application includes quantification of mass transfer of the electron per molecule, measurement of absolute quantity of the analyte, electrolytic synthesis of new materials (generally in quantity of milligram).

001197

Reference electrode is sold separately.

Catalog No.	Description	Qty
013647	SBC Bulk electrolysis cell	
Contents		Qty
012632	Sample vial (100 mL)	1
012961	Platinum counter electrode 23 cm	1
013648	Teflon cap for SBC	1
013616	PCE Porous carbon electrode	1
001198	Lid for counter electrode	1
001196	Chamber for counter electrode	1
001236	O-ring for counter electrode	1
009131	Port plug	1
000178	Stirrer bar	1
(010537)	Purge tube (ETFE), 30 cm	1
Optional item		
013580	Sample vial for alkaline solution (100 mL) (10 pcs)	
012652	Water-Jacketed glass cell (100 mL)	

Cell Vials



● Tolerance of each dimension is approximately ± 0.5 mm. ● The inner diameter (ID) is the size at the top side.

Catalog No.	Description	Vol (mL)	OD (mm)	ID (mm)	Height (mm)	Qty	Purpose
011504	Sample vial ¹	5	18	15.6	30	10	VC-4
001056	Sample vial ¹	20	28	25.6	50	10	SVC-2, SVC-3
012632	Sample vial ¹	100	50	46.4	72	1	RRDE-3A, Bulk Electrolysis Cell
013580	Sample vial for alkaline solution ²	100	51.5	46.5	72	10	RRDE-3A, Bulk Electrolysis Cell
013581	Sample vial for alkaline solution ²	200	67	62	72	8	RRDE-3A, Bulk Electrolysis Cell
012672	Water-Jacketed glass cell	5	40	15.6	40	1	VC-4
001051	Water-Jacketed glass cell	20	55	25.6	50	1	SVC-2, SVC-3
012652	Water-Jacketed glass cell	100	70	46.4	80	1	RRDE-3A, Bulk Electrolysis Cell
013596	Teflon cap for CV (100mL)					1	For 012632, 012652, 013580
013582	RRDE-3A Teflon cap (for 200 mL)					1	For 013581
001209	Cell holder for 20 mL vial					1	SVC-2, SVC-3

*1 Hard glass for scientific research *2 Polymethyl pentene

6

Flow Cells

Electrochemical Flow Cells

Our working electrodes for flow cell are mounted in blocks of PEEK. This resin protects the electrodes from external noise and allows researchers to utilize them regardless the content of mobile phase of HPLC because of their hardness and organic solvent-resistance. Glassy carbon is usually chosen for the redox reaction study on liquid chromatography. Platinum, Gold, Carbon paste and Nickel electrodes are utilized for special purposes.

Working electrodes for Flow cell



Feature

- Excellent chemical resistance
- Easy maintenance of the working electrode
- Working electrode can be polished with PK-3 Polishing kit

Catalog No.	Description	Size	Purpose	
Dual	001000	Glassy carbon electrode (Dual 3 mm)	25 × 25 mm	For CF, general redox measurements
	001002	Gold electrode (Dual 3 mm)	25 × 25 mm	For CF, measurement of thiol-related compounds
	001012	Platinum electrode (Dual 3 mm)	25 × 25 mm	For CF, measurement of hydrogen peroxide & oxidized substances
	001008	Silver electrode (Dual 3 mm)	25 × 25 mm	For CF, measurement of cyano-sulfide
	001009	Nickel electrode (Dual 3 mm)	25 × 25 mm	For CF, amino acids measurement by chemically modified electrode
	001004	Carbon paste electrode (Dual 3 mm)*	25 × 25 mm	For CF, modified electrode measurement using carbon paste
	001006	Glassy carbon / Gold electrode	25 × 25 mm	For CF, others
	012583	Glassy carbon / Platinum electrode	25 × 25 mm	For CF, others
Single	012124	Glassy carbon electrode (Single 3 mm)	25 × 25 mm	For RF, general redox measurements
	001016	Glassy carbon electrode (Single 6 mm)	25 × 25 mm	For RF, general redox measurements
	000999	PFCE Carbon electrode (Single 3 mm)	25 × 25 mm	For RF, general redox measurements
	011155	Gold electrode (Single 3 mm)	25 × 25 mm	For RF, measurement of thiol-related compounds
	009908	Platinum electrode (Single 3 mm)	25 × 25 mm	For RF, measurement of hydrogen peroxide and oxidized substances
	010251	Carbon paste electrode (Single 3 mm)*	25 × 25 mm	For RF, modified electrode measurement using carbon paste

*001010 CPO Carbon paste oil base (1 g) is sold separately (p. 9). Note that the carbon paste is not filled up.

CF: Cross Flow cell RF: Radial Flow cell

Structure of the working electrode

The dual glassy carbon electrode is considered to be a standard working electrode for cross flow cell. It is composed for two glassy carbon electrodes, of 3 mm placed in series. Also it could be rotated 90 degrees and applied as a parallel mode. The selectivity improves with the application of dual series electrode. In the parallel mode, identification of the substance, from the different applied voltage response ratio, is possible. For the dual electrode, the electrode surface area doubles by using the jumper connector, and high sensitivity analysis becomes possible. For the working electrode, the platinum/gold electrode and others are also available.

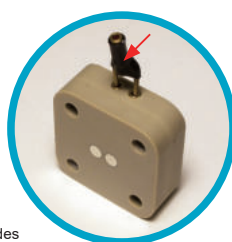

002245 Jumper connector for dual electrodes

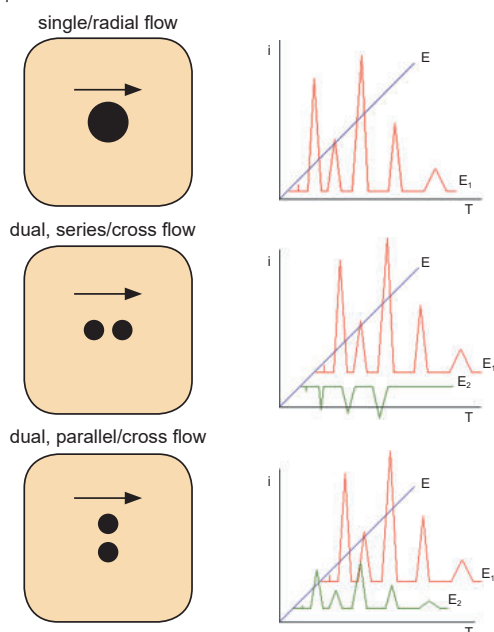

Cross Flow Cell

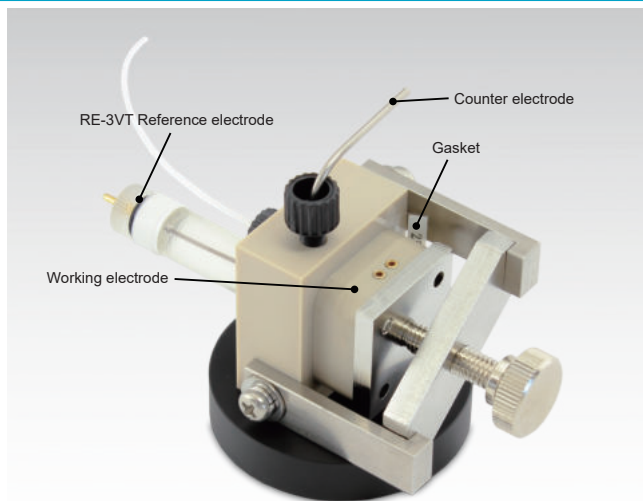

Catalog No.	Description
012798	Cross Flow cell

Cross Flow Cell is capable of quantitation up to the level of 10^{-15} mol by the flow rate : 1 mL/min - 100 μ L/min.

Feature

- Detection electrode for HPLC
- for Flow injection analysis
- for bio-sensor development

Schematic diagram of Cross flow cell

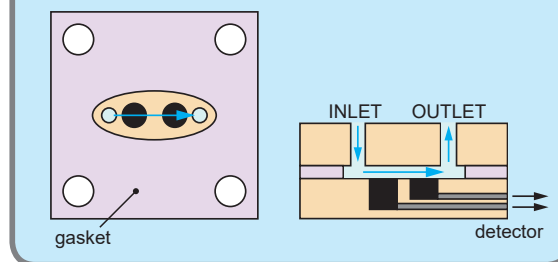

* Working electrode, Reference electrode and Gasket are sold separately.

Radial Flow Cell

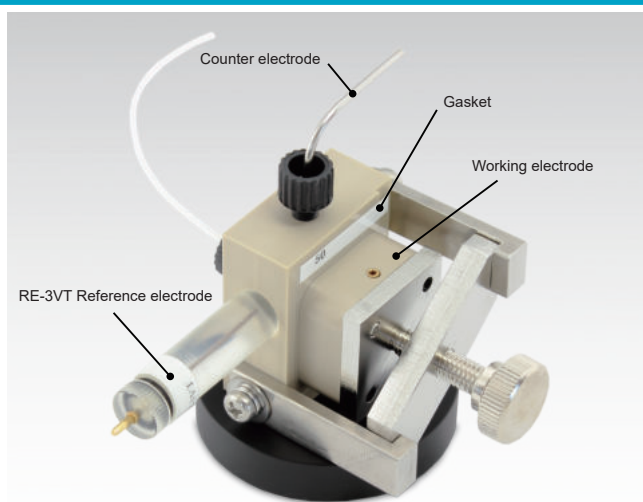

Catalog No.	Description
012799	Radial Flow cell

Radial Flow Cell is developed for microbore chromatography. Its detecting efficiency will improve when flow rate is 10 μ L/min or lower. This flow cell consists of thin layer electrode and symmetric design.

The wall-jet of analyte hits on the surface of electrode, then flows in thin layer and circulated form to the perimeter from the center of the electrode, resulting in enhanced sensitivity.

Schematic diagram of Radial flow cell

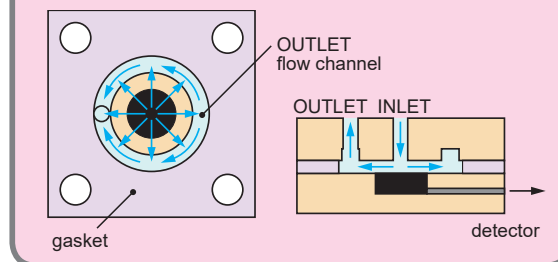

* Working electrode, Reference electrode and Gasket are sold separately.

Optional items

Catalog No.	Description
013488	RE-3VT Reference electrode screw type (Ag/AgCl)
013489	RE-7VT Non Aqueous reference electrode screw type (Ag/Ag ⁺)
001046	TG-2M Teflon Gasket (Cross Flow) / 12 μ m (4 pcs)
001047	TG-5M Teflon Gasket (Cross Flow) / 25 μ m (4 pcs)
001048	TG-6M Teflon Gasket (Cross Flow) / 50 μ m (4 pcs)
012801	TG-8M Teflon Gasket (Cross Flow) / 100 μ m (4 pcs)
001146	TG-2MR Teflon Gasket (Radial Flow) / 12 μ m (4 pcs)
001147	TG-5MR Teflon Gasket (Radial Flow) / 25 μ m (4 pcs)
001148	TG-6MR Teflon Gasket (Radial Flow) / 50 μ m (4 pcs)
012802	TG-8MR Teflon Gasket (Radial Flow) / 100 μ m (4 pcs)
002245	Jumper connector for dual electrodes
012912	0.04" Single lead connector (2 pcs)

QCM Flow Cells

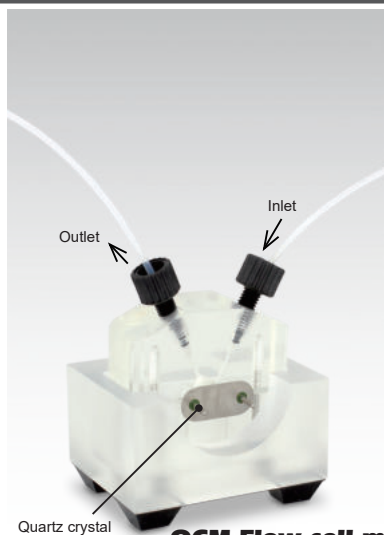

QCM Flow cell mode

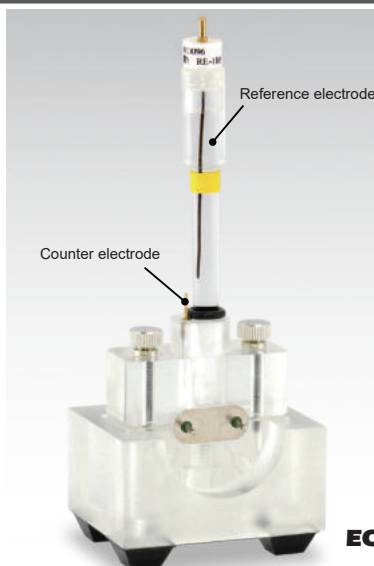

EQCM mode

Contents for QCMT Flow cell

Flow cell; Batch cell; Cap; Flow cell holder; Pt counter electrode; Fitting PEEK; Fixing screw; Silicon O-ring; Teflon tube

The quartz crystal microbalance (QCM) technique under coupling of electrochemistry and crystal oscillation is very useful to determine many compounds such as metal proteins, metal ions and thiol-conjugated oligonucleotides. The Resonance frequency of quartz changes when material attaches to the electrode's surface. This product is capable of super-micro quantitative analysis by using this unique behavior. However, for the best performance, use a degassed sample, to avoid bubbles. QCMT Flow cell is reversible. With an inverted position of the blocks, it is possible to change from static to flow measurements.

Catalog No.	Description
013486	QCMT Flow cell kit
Optional items	
013610	Quartz crystal Au (5 pcs)
013447	Quartz crystal Pt (3 pcs)
012772	Blank Crystal with holder (5 pcs)
012167	RE-1B Reference electrode (Ag/AgCl)
013613	RE-1BP Reference electrode (Ag/AgCl)
012171	RE-7 Non Aqueous reference electrode (Ag/Ag ⁺)

Quartz crystal

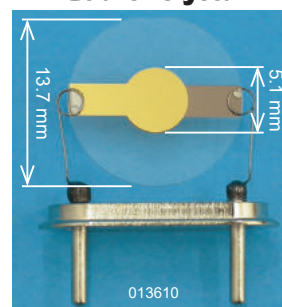

Frequency: 7.995 MHz



ALS support product manual
<https://www.als-japan.com/support-product-manual.html>
Manual download link

EQCM Flow Cells

Combination of QCM and electrochemical measurement in an unique flow cell.

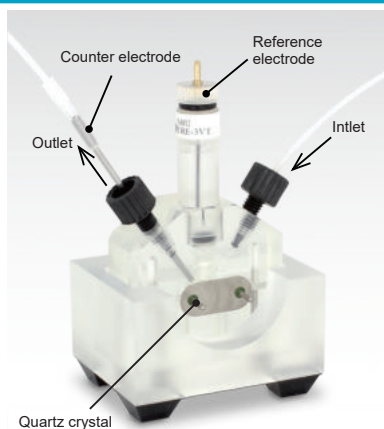

Contents for EQCMT Flow cell

Flow cell; Batch cell; Cap; Flow cell holder; Pt counter electrode; Stainless tube (Counter electrode for flow cell); Fitting PEEK; Fixing screw; Silicon O-ring; Teflon tube

The two blocks of the EQCMT Flow cell are constructed using Polymethyl pentene. It gives a high resistivity for chemical compounds. As well as QCMT Flow cell, this cell is reversible. With an inverted position of the blocks, it is possible to change from flow to static measurements.

Catalog No.	Description
013487	EQCMT Flow cell kit
Optional items	
013610	Quartz crystal Au (5 pcs)
013447	Quartz crystal Pt (3 pcs)
012772	Blank Crystal with holder (5 pcs)
013488	RE-3VT Reference electrode screw type (Ag/AgCl)
013489	RE-7VT Non Aqueous reference electrode screw type (Ag/Ag ⁺)



ALS support product manual
<https://www.als-japan.com/support-product-manual.html>
Manual download link

7

Spectroelectrochemistry

Spectroelectrochemistry (SEC) is aimed at the investigation of electrochemical reaction mechanism and the interface structure between electrolyte solution and electrode. Remarkable progress in this field and related technology enables SEC to be applied in wide areas. Nowadays, the relation between absorbance and potential for reversible or quasi-reversible system is theoretically elucidated, on which basis the analysis of electrochemical characteristics becomes possible for the system otherwise difficult with only the result of voltammogram. Typical example is redox enzyme cytochrome c and methylene blue.

Application

- Real-time monitoring of chromatic change by redox reaction
- Analysis of the charge transfer at the electrode/liquid interface
- Spectrometric measurement of near/surface of electrodes
- Absorbing spectrum of the product and intermediate
- Parameters: concentration, diffusion coefficient and life time

Spectroelectrochemical Batch System

SEC-C Thin Layer Quartz Glass Spectroelectrochemical cell kit

SEC-C Thin Layer Quartz Glass Spectroelectrochemical cell kit uses platinum or gold mesh electrode as a working electrode. We offer 0.5 and 1.0 mm optical path length cells. After setting the mesh electrode, the activity area for the cell is about 6 mm diameter with a center at 15 mm above of the bottom. For reference electrode, the RE-1B, RE-1BP or RE-7 is recommended.

Feature

- Two variety optical path length (0.5 and 1.0 mm)
- Designed to use the 6.0 mm reference electrode
- Two variety of working electrodes (Au or Pt)
- Be able to use in a standard spectrometer

Set up

SEC-C Thin Layer Quartz Glass Spectroelectrochemical cell Kit

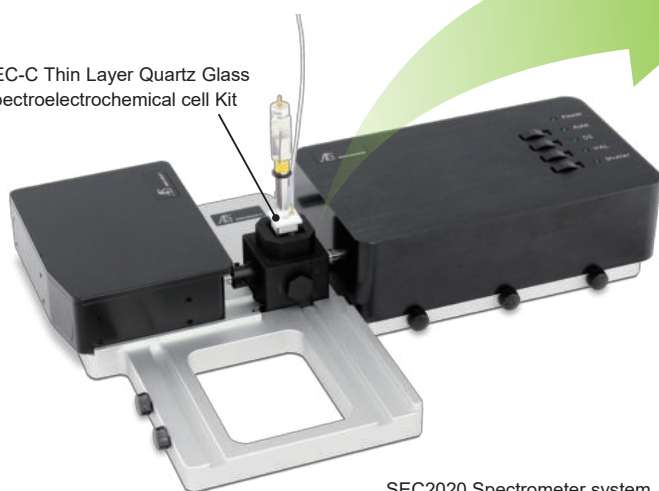

SEC2020 Spectrometer system



ALS Spectroelectrochemical setup

<https://www.als-japan.com/1874.html>

[Setup introduction link](https://www.als-japan.com/1874.html)



Optical path length 1.0 mm cell

Kinds of working electrodes

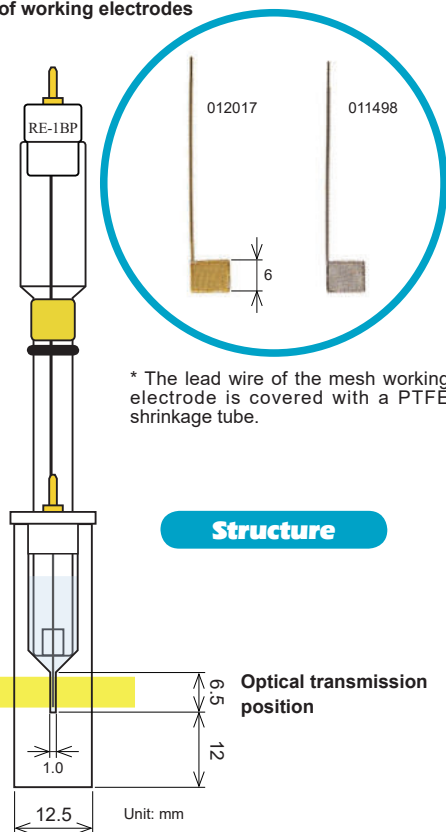

Structure

Optical transmission position

Optical path length 1.0 mm cell

The optical path length 1.0 mm is most suitable for basic spectrum electrochemistry measurements. Theoretically, it is possible to get the same result as for 0.5 mm with a half concentration sample.



ALS support product manual
<https://www.als-japan.com/support-product-manual.html>
Manual download link

Catalog No.	Description
013510	SEC-C Thin Layer Quartz Glass Spectroelectrochemical cell Kit (Pt)
013511	SEC-C Thin Layer Quartz Glass Spectroelectrochemical cell Kit (Au)
Contents	
013703	SEC-C/C05 Pt counter electrode
013512	SEC-C Thin Layer Quartz Glass cell
011501	SEC-C Teflon cap
(010537)	Purge tube (ETFE) 10 cm
Working Electrodes	
011498	SEC-C Pt Gauze working electrode
012017	SEC-C Au Gauze working electrode
Optional items	
012167	RE-1B Reference electrode (Ag/AgCl)
013613	RE-1BP Reference electrode (Ag/AgCl)
012171	RE-7 Non Aqueous reference electrode (Ag/Ag ⁺)

Optical path length 0.5 mm cell

Kinds of working electrodes

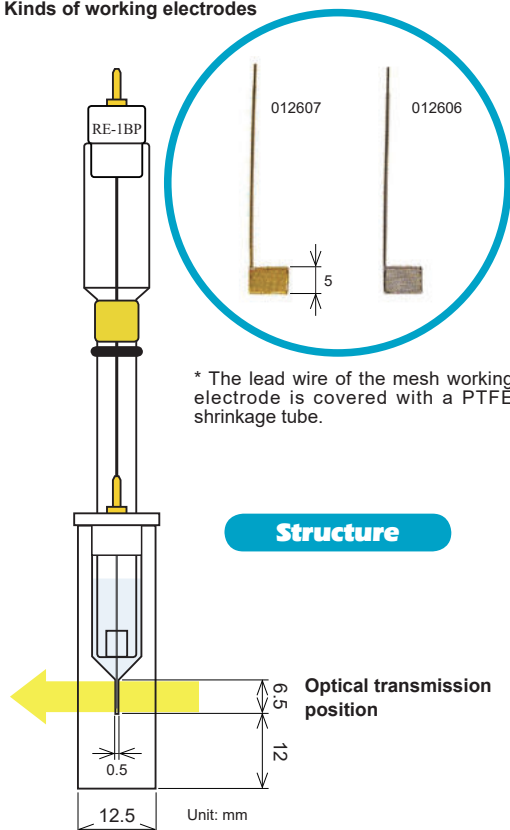

Structure

Optical transmission position

Optical path length 0.5 mm cell

The optical path length 0.5 mm has an electrolysis time shorter than 1.0 mm cell. The short time for the electrolysis makes possible to have a stable result as for, measurement of the high volatile organic solvent, detection of the unstable electrolysis products, and others.

* There is a specific working electrode for 0.5 mm optical path length. The working electrode for 1.0 mm optical path length can not be used in 0.5 mm optical path length quartz cell.



ALS support product manual
<https://www.als-japan.com/support-product-manual.html>
Manual download link

Catalog No.	Description
013700	SEC-C05T Thin Layer Quartz Glass Spectroelectrochemical cell Kit (Pt)
013701	SEC-C05T Thin Layer Quartz Glass Spectroelectrochemical cell Kit (Au)
Contents	
013703	SEC-C/C05 Pt counter electrode
013702	SEC-C05T Thin Layer Quartz Glass cell
011501	SEC-C Teflon cap
(010537)	Purge tube (ETFE) 10 cm
Working Electrodes	
012606	SEC-C05 Pt Gauze working electrode
012607	SEC-C05 Au Gauze working electrode
Optional items	
012167	RE-1B Reference electrode (Ag/AgCl)
013613	RE-1BP Reference electrode (Ag/AgCl)
012171	RE-7 Non Aqueous reference electrode (Ag/Ag ⁺)

Comparison of 0.5 and 1.0 optical path length cell



The electrolysis time for the 0.5 mm optical path length cell is theoretically a half, compared with the 1.0 mm cell. It is the opposite, for the concentration, when the same result for the 1.0 mm cell is possible for a half of the concentration compared with the 0.5 mm cell. You could select the optical path length and the working electrode appropriate for your research purpose.

For the comparison of 0.5 and 1.0 optical path length cell, sometimes a difference between theoretical and experimental value may occur due to experimental conditions and so on.

Optical path length	Merit	Demerit
0.5 mm	High electrolytic speed	Difficult maintenance
1.0 mm	Easy maintenance	Slow electrolytic speed

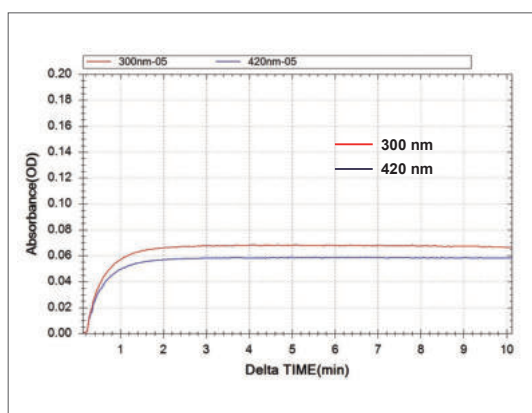

Fig.2-1. Absorbance for electrolysis performed with 0.5 mm optical path length cell

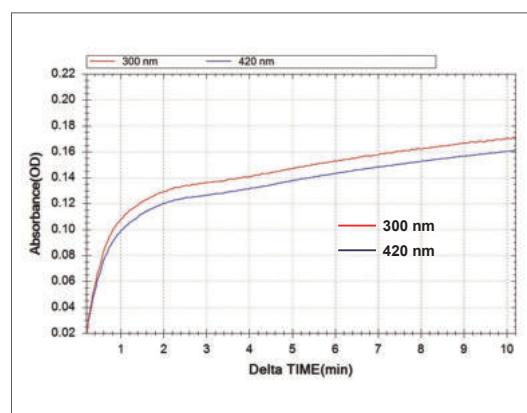

Fig.2-2. Absorbance for electrolysis performed with 1.0 mm optical path length cell

A 2 mM potassium ferrocyanide ($K_4[Fe(CN)_6]$) was subjected to an electrolysis reaction at 0.6 V until its equilibrium, and 1 M KNO_3 solution was used as a reference. The oxidation reaction was monitored by the comparison of the absorbance change in function of the time at wavelengths of 300 and 420 nm.

Measurement example using cuvette type spectroelectrochemical cell

UV-visible absorption spectrum can be obtained by measuring the absorbance of substances involved in the redox reaction by using SEC-C Spectroelectrochemical cell (1.0 mm optical path length). The CV of 2 mM potassium ferrocyanide aqueous solution is taken to confirm the redox potential. The Fig. 3-2 shows the time domain of the differential absorption spectrum at constant potential electrolysis at 0.25 V, where the oxidation reaction occurs.

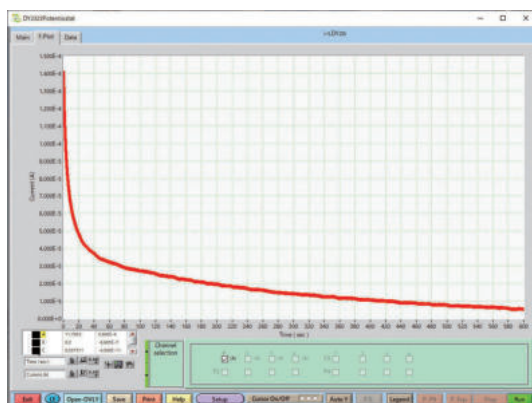

Fig. 3-1. Constant potential electrolysis for 2 mM potassium ferrocyanide.

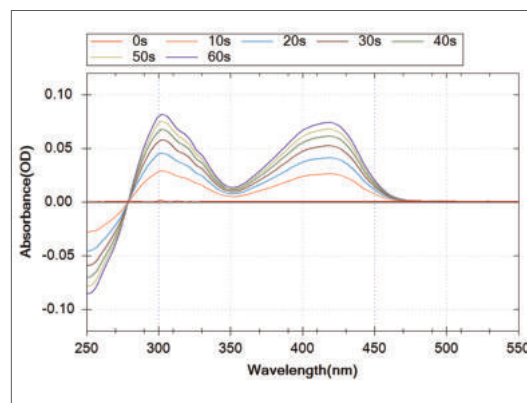
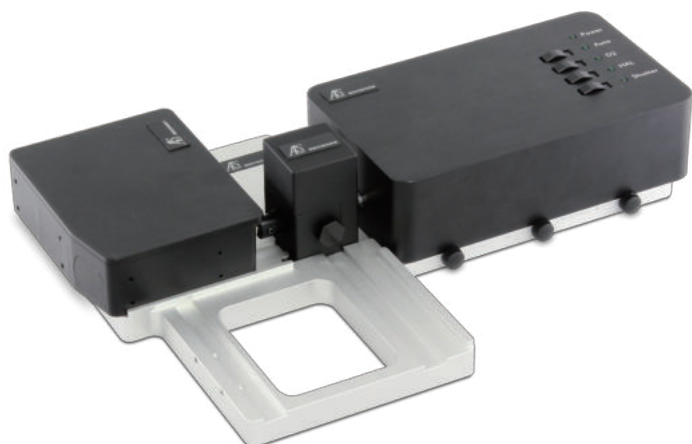

Fig. 3-2. Absorbance measurement for 2 mM potassium ferrocyanide.

SEC2020 Spectrometer system

Wide wavelength range spectrometer



Spectrometer structure



- | | |
|-----------------------|---------------------------|
| 1. SMA905 connector | 4. Grating |
| 2. Slit | 5. Focus mirror |
| 3. Collimating mirror | 6. 2048 element CCD array |

The SEC 2020 spectrometer system is a spectrometer that enables various spectrometric measurements, focusing on spectroelectrochemical measurements. The high-performance grating and optical design, makes possible to measure with high sensitivity in a wide wavelength range, from ultraviolet to near infrared (UV/VIS/NIR), with a single unit.

For the light source, a compact modularized deuterium halogen lamp is used, which is fixed to the cell holder on the accessory platform for the measurement.

Furthermore, the spectrometer and the light source come with SMA905 connector, which makes possible to connect various optical fibers and probes, to construct the original measurement system.

Feature

- Wide wavelength UV/VIS/NIR
- High sensitivity, resolutions and quality
- Deuterium halogen light source
- Measuring platform and analysis software included
- SMA 905 connection terminal
- Exclusive storage box

Application

- Spectroelectrochemical measurements
- Analysis of solution properties
- Film thickness/composition
- Fluorescence detection*
- Environmental (water and soil) analysis

* For fluorescence detection a high power light source, as high power LED is required.

Catalog No.	Description	
013609	SEC2020 Spectrometer system	
Specification		
Spectrometer	Description	SEC2021-025-DUVN
	Detector	2048 element linear silicon CCD array
	Wavelength range	200 - 1025 nm
	Grating	Blaze wavelength (300 nm)
	Slit	25 μm
	Wavelength resolution	1.3 nm
	Fiber connector	SMA905 Core diameter: 600 μm NA=0.22
Light source	Interface	USB 2.0
	Operating system	Windows™ 8.1 / 10, 32/64 bit
	Size (W x D x H)	86 x 110 x 32 mm
	Description	SEC2022
	Light type	Deuterium halogen light source
	Wavelength range	200 - 1700 nm
	Stability	< 0.1 %
	Drift	< 0.25 %/h
	Bulb life	> 1000 h (D2 lamp) > 2000 h (halogen lamp)
	Fiber connector	SMA905
Size (W x D x H)	100 x 165 x 46 mm	
Cuvette holder description	SEC2023	
Platform description	SEC2024	
Software	SpectraSmart	



Spectroelectrochemical Flow System

SEC-3F Spectroelectrochemical flow cell

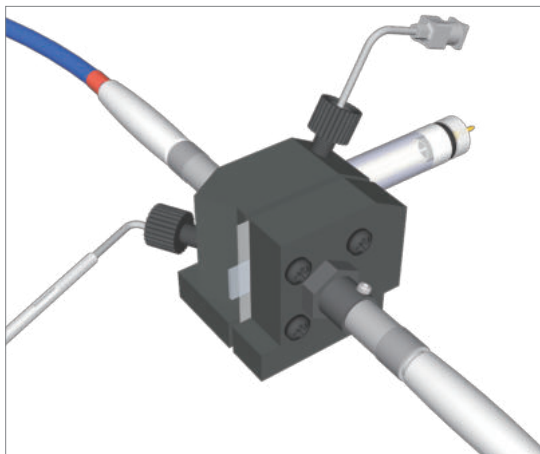

Feature

- Thin-layer cell measurement
- Variety of working electrode
- Connection to a variety of the optical fiber type spectrometer



ALS support product manual
<https://www.als-japan.com/support-product-manual.html>
Manual download link

Catalog No.	Description
013684	SEC-3F Spectroelectrochemical flow cell

Using the spectroelectrochemical flow cell, it is possible to have different optical path length by changing the gasket. We offer, as an optional item, a silicon and Teflon gasket with 100, 250 and 500 μm of the thickness. Flow injection analysis or stopped flow analysis with thin layer cells which was impossible with SEC-C Thin Layer Quartz Glass Spectroelectrochemical cell kit became possible.

The SEC-3F can be connected to a variety of the optical fiber type spectrometer by setting the collimating lens. Depending on the research purpose you can select the working and reference electrodes. For working electrode, we offer: ITO and platinum, gold or carbon grid electrodes. For reference electrode: RE-3VT Reference electrode screw type (Ag/AgCl) and RE-7VT Non Aqueous reference electrode screw type (Ag/Ag⁺).

Configuration

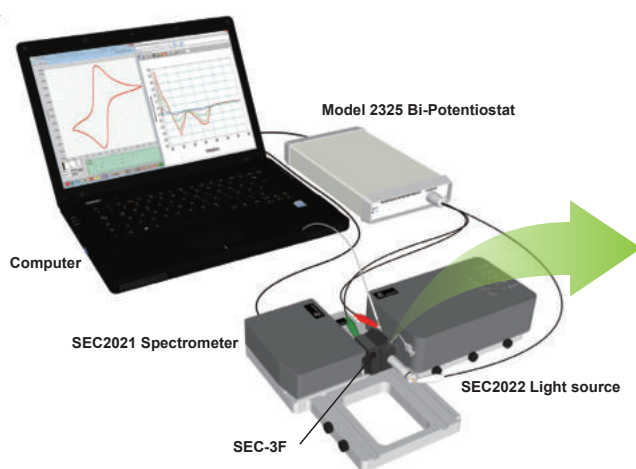

Structure diagram of Spectroelectrochemical flow cell

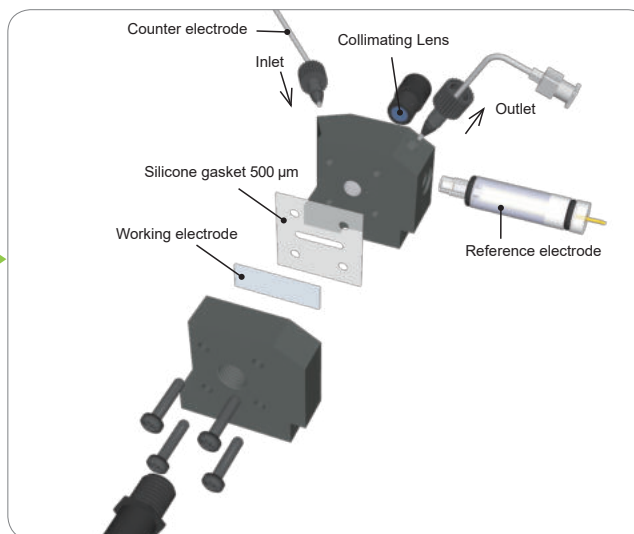

Optional items

1) Gasket

Catalog No.	Description	Thickness
012661	SEC-2F/3F S500 Silicone Gasket (4 pcs)	500 μm
012664	SEC-2F/3F T500 Teflon Gasket (4 pcs)	500 μm
012665	SEC-2F/3F T250 Teflon Gasket (4 pcs)	250 μm
012666	SEC-2F/3F T100 Teflon Gasket (4 pcs)	100 μm

2) The full list of the working electrodes are shown in the next page.

3) Reference electrode

Catalog No.	Description
013488	RE-3VT Reference electrode screw type (Ag/AgCl)
013489	RE-7VT Non Aqueous reference electrode screw type (Ag/Ag ⁺)

4) Optical fiber

012667	SEC-2F/3F 400 μm Optical Fiber SR (25 cm)
012685	SEC-2F/3F 400 μm Optical Fiber SR (2 m)
013688	UV/VIS Collimating Lens, 200-2000 nm

Comparison of the absorbance for different gasket thickness

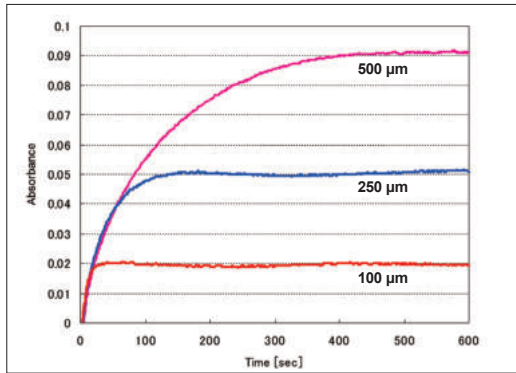

Fig.4-1. Changes of the equilibrium time in different gasket thickness.

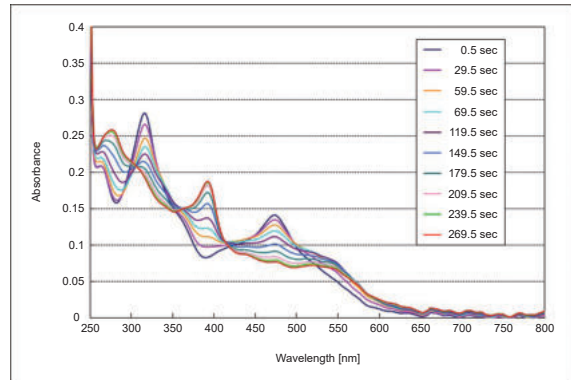

Fig.4-2. Electrolysis spectrum change of Vitamin B₁₂ derivative complex.

The absorbance, at 420 nm, during electrolysis of the potassium ferrocyanide, in function of time, was investigated using 100, 250 and 500 μm thickness gasket. For the measured sample, using the 100 μm gasket, in 40 seconds the equilibrium was shown (Fig.4-1). The 250 μm gasket was used for the monitoring of the electrolysis spectrum of the vitamin B₁₂ derivative complex (Fig.4-2).

Spectroelectrochemical Electrodes

ITO Optically transparent electrode

ITO (Indium Tin Oxide) electrode is generally used for spectroelectrochemical measurements. ITO electrode transmits the light of the visible range, but do not transmit the light of ultraviolet range. The thickness of the ITO membrane is 100 ± 10 nm, and the resistivity is 15 ± 1.5 Ω/sq^{*1}.

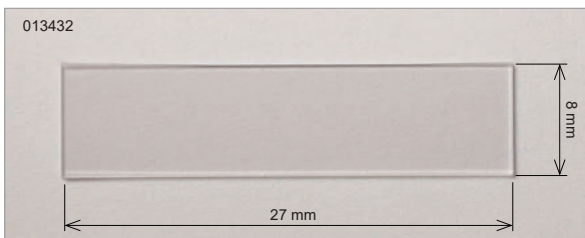

- *1. The manufacturer guarantee value.
- *2. Custom-made ITO electrode is also available.

Catalog No.	Description
013432	ITO11 electrode 8 x 27 x 1.1 mm (10 pcs)
013435	ITO05 electrode 8 x 27 x 0.5 mm (10 pcs)
Others*2	
013433	ITO11 electrode 10 x 10 x 1.1 mm (10 pcs)
013434	ITO11 electrode 10 x 20 x 1.1 mm (10 pcs)
013436	ITO05 electrode 10 x 10 x 0.5 mm (10 pcs)
013437	ITO05 electrode 10 x 20 x 0.5 mm (10 pcs)

Grid Electrode

Grid electrode is produced by the deposition of the platinum, gold or carbon onto the quartz glass. The dimension of the glass is 8 x 27 mm, with a 1 mm of the thickness, and the grid line is 100 μm width with a distance of the 150 μm between lines.

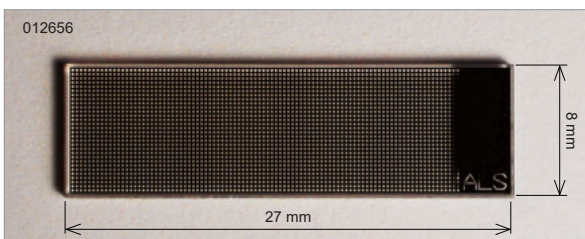

Catalog No.	Description
012655	SEC-2F/3F Pt grid electrode for flow cell
012656	SEC-2F/3F Au grid electrode for flow cell
012657	SEC-2F/3F Carbon grid electrode for flow cell

Schematic diagram of the grid

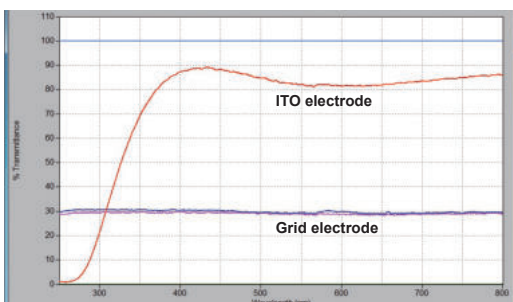
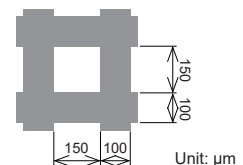

The light transmittance was compared with ITO electrode and Grid electrode (Au, Pt and Carbon) on a quartz glass as a reference. For ITO electrode the light cannot be transmitted easily in an ultraviolet range. The transmittance is about 10% at 280 nm of the wavelength. For wavelength above 400 nm the transmittance is above 80%. Compared with the quartz glass, the light transmission for grid electrode is about 30%, however it could be used in an ultraviolet range.

Reference data:

The light transmittance is 50 – 55% for SEC-C Platinum mesh electrode.

PK-3 Electrode Polishing kit

Polishing refreshes working electrode response

The purpose of the polish is to remove redox reaction products accumulated on the working electrode surface. The polishing maintains a good condition of working electrode for CV/Flow cell.

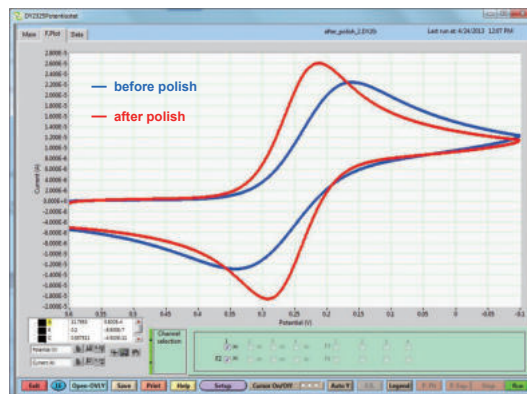

Glassy Carbon electrode

With repeated electrochemical redox reaction experiments, the adhesion of the experimental products onto the electrode surface takes place and the electron transfer rate is attenuated gradually. If the electron transfer speed becomes slow, the difference between peak potentials for oxidation and reduction will broaden.



Upon refreshing the electrode surface by polishing, the electron transfer rate will increase again. Consequently, the peak potential difference becomes narrow and returns to an ideal CV.

Instructions to polish the working electrode surface with PK-3

STEP 1



ALS PK-3 movie
<https://www.als-japan.com/1634.html>
Support Movie link

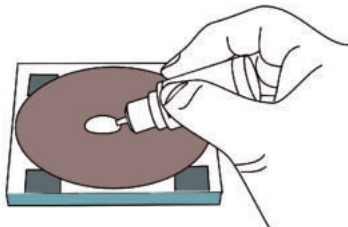

Prepare the glass plate, and put a few drops of polishing diamond on diamond polishing pad.

STEP 2

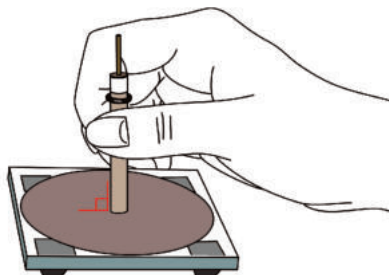

Hold the CV electrode at right angle to the pad.

STEP 3

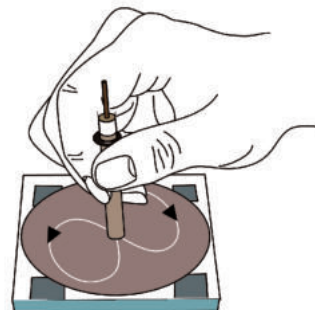

Polish in a circular motion, for 30 seconds to 2 minutes. Rinse the electrode surface with distilled water.

Catalog No.	Description		
013223	PK-3 Electrode Polishing kit		
	Contents	Qty	Purpose
012620	0.05 μm polishing alumina (20 mL)	1	For final polishing
012621	1 μm polishing diamond (10 mL)	1	For intermediate polishing
(012600)	Alumina polishing pad	10	For final polishing
(012601)	Diamond polishing pad	10	For intermediate polishing
013222	Replacement glass plate for PK-3	1	Glass plate to stick the polish pad
	Optional items		Purpose
013234	6 μm polishing diamond (10 mL)		For rough polishing
012600	Alumina polishing pad (20 pcs)		For final polishing
012601	Diamond polishing pad (20 pcs)		For intermediate polishing
012610	Coarse polishing pad (20 pcs)		For rough polishing
012611	Emery paper UF800* (20 pcs)		For PG and PFCE electrode polishing

* For polishing using the emery paper, use it only with distilled water. Polishing alumina and diamond cannot be used in Pyrolytic graphite electrode (PGE) and Plastic formed carbon electrode (PFCE).

Glassy Carbon



Feature

- High-purity
- Excellent Stability as high as at 3,000 deg C in vacuum
- Well Inert against Chemical corrosion
- impermeability to gas and solution
- Significant hardness / strength
- Brings fine surface condition after polishing
- Favorable electric conducting property
- Low thermal expansion
- High resistance against inorganic and organic salts
- Good bio-compatibility
- Isotropic physical/chemical properties

We are dealing with various kinds of Glassy Carbon products. Customer's special processing order such as pipe, pot shape etc. or custom sizing order is also available.

Characteristics of Glassy carbon

Glassy Carbon has a quite unique structure. This material contains random combination of basal plane and edge plane. The figure, at the right, shows the model illustration introduced by G. M. Jenkins and K. Kawamura. It becomes an outstanding material, which can be used for the electrode in an analytical chemistry domain as electrochemical measurements, detection of high-speed liquid chromatography, biosensor and others.

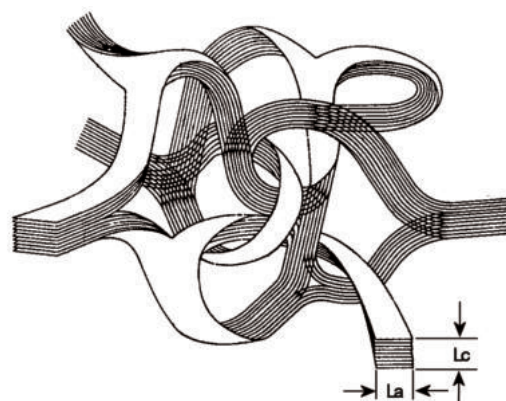

La: Intraplanar Microcrystalline Size, Lc: Interplanar Microcrystalline Size
G.M. Jenkins and K. Kawamura: Nature 231,175 (1971).

Size range available for customized product

Rod type: diameter, from 1 to 10 mm; length until 800 mm

Plate type: within 300 x 300 mm; thickness of 0.3, 0.5, and 1 to 6 mm

Film type: within 100 x 100 mm; thickness of 60, 100 and 140 μm

Furthermore, drilling, cutting and mirror polishing are also possible.

Catalog No.	Description	Size
Rod type		
010761	R-1 Glassy carbon rod	dia 1 x 100 mm
010762	R-2 Glassy carbon rod	dia 2 x 100 mm
010763	R-3 Glassy carbon rod	dia 3 x 100 mm
Plate type		
012825	P-1 Glassy carbon plate	10 x 10 x 1 mm
012086	P-1 Glassy carbon plate	25 x 25 x 1 mm
012087	P-2 Glassy carbon plate	25 x 25 x 2 mm
012088	P-3 Glassy carbon plate	25 x 25 x 3 mm
Film type		
012089	F-100 Glassy carbon film	25 x 25 x 0.1 mm
Powder type (Spherical)		
012090	S-12 Glassy carbon powder	0.4 - 12 μm, 10 g
012091	S-20 Glassy carbon powder	10 - 20 μm, 10 g

Physical property	Physical property	
	Other than Film	Film
Shape		
Density	1.42 g/cm ³	1.54 g/cm ³
Ash content	< 100 ppm	
Upper Temperature Limit in vacuum	3000 deg C	1000 deg C
Porosity	0 %	
Gas Transmission Rate	10 ⁻⁹ cm ² /s	10 ⁻¹¹ cm ² /s
Hardness	230 HV1	340 HV1
Bending Strength	260 N/mm ²	210 N/mm ²
Compressive Strength	480 N/mm ²	580 N/mm ²
Young's Modulus	35 kN/mm ²	
Thermal Expansion Coefficient (20 - 200 deg C)	2.6×10 ⁻⁶ 1/K	3.5×10 ⁻⁶ 1/K
Heat Conducting (30 deg C)	6.3 W/(m•K)	4.3 W/(m•K)
Electrical resistivity	45 μΩ•m	50 μΩ•m



BAS Inc. is close to "TOKYO SKYTREE".



www.als-japan.com

Manufactured by:

ALS Co., Ltd

Exclusive distributor:

BAS BAS Inc.

Address: 1-28-12, Mukojima, Sumida-ku, Tokyo 131-0033, JAPAN

Phone: +81-3-3624-0331 Fax: +81-3-3624-3387

URL: <https://www.als-japan.com/>

Email: sales@als-japan.com

ALS Co., Ltd is a member of BAS Inc.

Local distributor: